

# WEKOS

cucina, scalda, arreda



cucine · cookers · cuisinières

### **“Non vi è fuoco simile alla passione d’amore”**

Wekos domina il fuoco con passione, semplicità e creatività per realizzare stufe e cucine che hanno un’anima. Con un lavoro artigianale guidato dalla cura per il dettaglio e dall’amore per il bello, vengono realizzati modelli che dialogano tra tradizione e innovazione e che rappresentano il frutto di una continua ricerca sospesa tra design e funzionalità.

Entrare nelle case, con discrezione e carattere, proponendo elementi d’arredo che espletino le loro funzioni con efficacia, nel rispetto per la natura e che personalizzino il vostro ambiente senza invadenza perché lì i protagonisti siete voi: un obiettivo ambizioso, da raggiungere anche con esperienza.

### **“There is no fire like passion of love”**

Wekos rules over fire with passion and simplicity creating stoves and cookers with a soul.

Ours is an artisan work led by our eye for detail and our love for beauty; our creations combine tradition with innovation and are the result of our continuous commitment in research on both design and functionality.

To enter your world with discretion and yet with character, with furniture pieces that perform their duty efficiently, in the respect for nature; they characterize and blend perfectly into your spaces where you are the protagonist: this is our goal, which we ambitiously aim at achieving strong with our experience.

### **“Il n’est pas de feu égal à la passion amoureuse“**

Wekos domine le feu avec passion, simplicité et créativité pour réaliser des poêles à bois et des cuisinières à bois qui ont une âme.

Par un travail artisanal guidé par le soin du détail et l’amour du beau, nous réalisons des modèles qui dialoguent entre tradition et innovation et qui représentent le fruit d’une recherche continuelle suspendue entre design et performances.

Entrer au cœur des maisons, avec discrétion et caractère, en proposant des éléments décoratifs qui jouent leur rôle avec efficacité, dans le respect de la nature et qui personnalisent votre intérieur sans être envahissants, parce que les protagonistes, c’est vous : un objectif ambitieux, que seule l’expérience permet d’atteindre.



## Con Wekos il calore è di casa

Produciamo da più di 40 anni, in origine come A.R.CO. snc dei F.lli Corradi e poi dal 1994 come WEKOS srl prodotti di alta qualità: stufe, cucine e termocucine a legna o combinate legna + gas/elettrico e cucine di cottura destinate a durare nel tempo.

Le nostre cucine sono apprezzate per l'ampia possibilità di personalizzazione (finiture, rivestimenti, piedi, maniglie, decori, top cottura sono disponibili in molteplici varianti) e per la qualità dei materiali impiegati nella costruzione:

- porte e piedi in pressofusione di ottone;
- fusione di ghisa "Made in Italy" per le piastre di cottura, le porte della versione Rustica, i piedi lavorati, lo scarico dei fumi, le griglie dei focolari;
- refrattari delle camere di combustione con grosso spessore (4 / 5 cm);
- caldaie delle termocucine in acciaio inox 304 con garanzia per 10 anni;
- spessore delle lamiere di 1,5 / 2,5 / 3,00 mm;
- maniglie in porcellana o pressofusione di ottone;
- rivestimento in piastrelle di ceramica lisce o con decoro dipinto a mano, pannelli in lamiera smaltata, pietra serpentino bocciardata o sabbata;
- bruciatori in pressofusione di ottone e griglie in fusione di ghisa per i piani cottura Wekos.

Questo catalogo racconta la bellezza delle nostre collezioni: ANTICO CASALE, dalle linee più classiche pensate per ambienti rustici e HARMONY, con linee più moderne e armoniose, adatta a diversi tipi di ambiente. I modelli nascono per soddisfare ogni gusto ed esigenza, assecondando la volontà di personalizzare la cucina con arredi unici, come i vostri desideri.

## With Wekos, warmth is at home

We have been producing high quality products for over 40 years, originally as A.R.CO. snc dei F.lli Corradi and then, since 1994, as WEKOS srl: wood-burning or combined wood + gas/electric stoves, cookers and thermo cookers, as well as cooking ranges designed to last over time.

Our cookers are appreciated for their wide range of customization options (finishes, claddings, feet, handles, decorations, cooking hobs are available in many variations) and for the quality of the materials used in their construction:

- doors and feet in die-cast brass;
- "Made in Italy" cast iron for the cooking hobs, the doors of the Rustica version, the machined feet, the smoke outlet, the hearth grates;
- ultra thick refractory materials of the combustion chambers (4/5 cm);
- 304 stainless steel thermo-cooker boilers with a 10-year guarantee;
- 1.5 / 2.5 / 3.00 mm sheet thickness;
- handles in porcelain or die-cast brass;
- cladding in smooth ceramic tiles or with hand-painted decoration, enamelled sheet metal panels, bush-hammered or sandblasted serpentine stone;
- die-cast brass burners and cast iron grids for Wekos hobs;

This catalogue tells the beauty of our Collections: ANTICO CASALE, with classic lines designed for rustic environments and HARMONY, with lines basically more modern and harmonious, suitable for different types of environments. The models are created to satisfy every taste and need, thus meeting the desire to customize the kitchen with unique furnishings, unique just like your desires.

## Avec Wekos, la chaleur est chez vous

Nous produisons depuis plus de 40 ans produits de haute qualité, à l'origine sous le nom d'A.R.CO. snc dei F.lli Corradi, puis, à partir de 1994, comme WEKOS srl : poêles à bois, cuisinières et cuisinières bouilleur à bois ou combinées bois + gaz/électrique, conçues pour durer dans le temps.

Nos cuisinières sont appréciées pour la large possibilité de personnalisation (finitions, revêtements, pieds, poignées, décorations, plaques de cuisson sont disponibles en plusieurs variantes) et pour la qualité des matériaux utilisés dans leur construction :

- Portes et pieds en laiton moulé sous pression ;
- Fonte « Made in Italy » pour les plaques de cuisson, les portes de la version Rustica, les pieds travaillés, le conduit d'évacuation des fumées, les grilles du foyer ;
- Matériaux réfractaires de grande épaisseur (4/5 cm) pour les chambres de combustion ;
- Chaudières des cuisinières bouilleur en inox 304 avec une garantie de 10 ans ;
- Épaisseur de tôle de 1,5 / 2,5 / 3,00 mm ;
- Poignées en porcelaine ou en laiton moulé sous pression ;
- Revêtement en carreaux de céramique lisses ou avec décoration peinte à la main, panneaux en tôle émaillée, pierre serpentine bouchardée ou sablée ;
- Brûleurs en laiton moulé sous pression et grilles en fonte pour plaques de cuisson Wekos ;

Ce catalogue raconte la beauté de nos collections : ANTICO CASALE, aux lignes classiques conçues pour les environnements rustiques et HARMONY, aux lignes plus modernes et harmonieuses, parfaites pour différents types d'environnements. Nos modèles sont créés pour satisfaire tous les goûts et besoins, en répondant au désir de personnaliser la cuisine avec un mobilier unique, à l'image de vos envies.

# Sommario | Summary | Index

## CUCINE E TERMOCUCINE A LEGNA

wood cookers and thermo cookers   cuisinières à bois et cuisinières bouilleur	6
601	7
601 CON FORNO SERENELLA	8
ANTICO CASALE CLASSIC 85	10
ANTICO CASALE CLASSIC 90	11
ANTICO CASALE CLASSIC 100	14
MONTE ROSA 90	16
HARMONY 90	17

## CUCINE E TERMOCUCINE COMBinate

dual system cookers and thermo cookers   cuisinières combinées et cuisinières bouilleur	19
120 LGE	20
120 LGE/F LOBELIA	21
135 LGE VIOLETTA	22
135 LGE/F ARNICA	24
ANTICO CASALE 360 LGE	25
ANTICO CASALE 150 LGE	27
ANTICO CASALE 160 LGE	29
ANTICO CASALE 165 LGE	30
ANTICO CASALE 175 LGE	32
ANTICO CASALE 180 LGE	34
ANTICO CASALE 190 LGE	35
MONTE ROSA 360	36
HARMONY 150 LGE	37
HARMONY 165 LGE	39
HARMONY 180 LGE	40

## CUCINE DI COTTURA

cooking appliances   cuisinières	41
ANTICO CASALE 60 GE	42
ANTICO CASALE 75 GE	43
ANTICO CASALE 90 GE	44
HARMONY 60 GE	46
HARMONY 75 GE	47
HARMONY 90 GE	48

## RIVESTIMENTI E ACCESSORI

claddings and accessories   revêtements et accessoires	49
--	----

# Legenda | Legend | Légende



Cucina  
Cooker  
Cuisinière



Termocucina  
Thermo cooker  
Cuisinière bouilleur



Potenza nominale (utile)  
Nominal heat output  
Puissance nominale (utile)



Potenza resa all'acqua  
Water heat output  
Puissance rendue à l'eau



Potenza resa all'ambiente  
Space heat output  
Puissance rendue à la pièce



m<sup>3</sup> riscaldabili in funzione isolamento termico  
m<sup>3</sup> that can be heated according to the thermal insulation  
m<sup>3</sup> chauffée en fonction de l'isolation thermique



Rendimento  
Efficiency  
Rendement



Peso netto  
Net weight  
Poids net



Scarico fumi  
Flue  
Evacuation fumées



Dimensioni utili focolare  
Useable space hearth  
Espace utile foyer



Dimensioni utili forno a legna  
Useable space oven  
Espace utile four à bois



Depressione media al camino  
Flue draft pressure  
Dépression moyenne à la cheminée



Classe di efficienza energetica  
Energy efficiency class  
Classe d'efficacité énergétique



Certificazione ambientale  
Environmental certification  
Certification environnementale



Consumo legna/Lunghezza legna  
Wood consumption/Lenght of firewood  
Consommation de bois/Longuer de bois



Potenza max forno elettrico multifunzione  
Multipurpose electric oven  
Multifonction électrique four



Dimensioni + volume forno elettrico multifunzione  
Size + volume multifunction electric oven  
Dimensions + volume four électrique multifonction



Agenzia di consulenza tecnica ed ecologica

Tutti i prodotti sono certificati **CE** secondo la norma **EN 12815:2006** per cucine e termocucine e sono conformi alla normativa **ECODESIGN 2022**.

All products are **CE** mark-approved according to the **EN 12815:2006** standard for cookers and thermo cookers and comply with the **ECODESIGN 2022**.

Tous les produits sont certifiés **CE** selon la norme **EN 12815:2006** pour les cuisinières et cuisinières bouilleur et sont conformes à la norme **ECODESIGN 2022**.

**Le caldaie delle termocucine WEKOS** sono costruite in acciaio inox 304. **GARANZIA 10 ANNI**. La garanzia decade nel caso di una non corretta installazione senza i dovuti sistemi di sicurezza. Il kit d'installazione non è incluso.

**ATTENZIONE!** Non si possono utilizzare gli apparecchi termo senza il circolo dell'acqua all'interno della caldaia.

**The boilers used for WEKOS thermo cookers** are made of stainless steel 304. **10 YEAR WARRANTY**. Incorrect installation or failure to use appropriate safety systems shall render the warranty null and void. The installation kit is not included.

**N.B.!** Thermo cookers cannot be used without water circulating in the boiler.

**Les chaudières des cuisinières bouilleurs WEKOS** sont construites en acier inox 304. **GARANTIE 10 ANS**. La garantie devient caduque en cas d'installation incorrecte sans les systèmes de sécurité obligatoires. Le kit d'installation n'est pas compris.

**ATTENTION!** Les cuisinières bouilleurs ne peuvent pas être utilisées si l'eau ne circule pas à l'intérieur de la chaudière.



# CUCINE E TERMOCUCINE A LEGNA



WOOD COOKERS  
AND THERMO COOKERS

CUISINIÈRES À BOIS  
ET CUISINIÈRES  
BOUILLEUR



# 601



Cucina a legna da 60 cm che racchiude in poco spazio un ampio focolare e una piastra radiante in ghisa con cerchi per la cottura a legna. È possibile incassarla tra i mobili predisponendo un pannello isolante sui fianchi.

60 cm wood-burning cooker combining a large hearth and a cast iron radiant plate with rings for wood-fired cooking in a small space. It can be fit between the furniture by placing an insulating panel on its sides.

Cuisinière à bois de 60 cm contenant, dans un espace réduit, un grand foyer et une plaque radiante en fonte avec cercles pour cuisiner au feu de bois. Il est possible de l'encastrer entre les meubles en plaçant un panneau isolant sur les côtés.

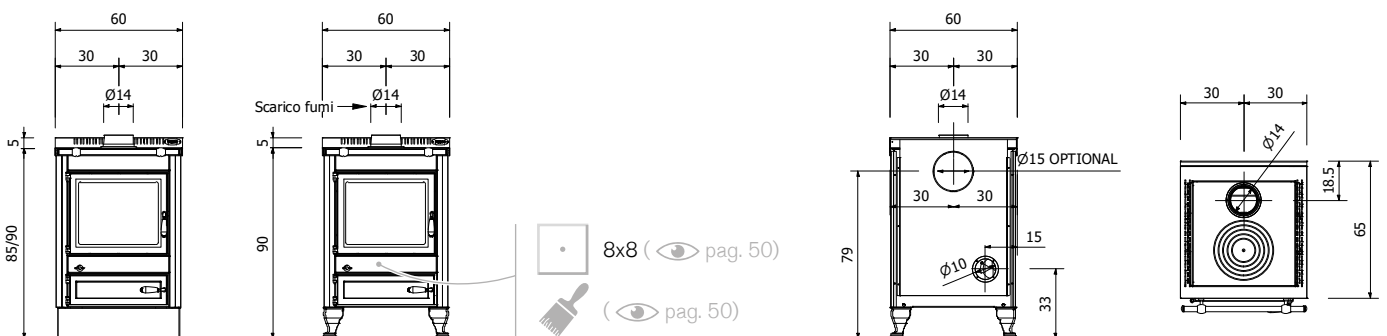

		<b>7,3</b>		-		<b>172</b>	-		<b>A</b>	-
	-	-	-	-		<b>Ø 14</b>	-	DM 186	★★★★	-
	-	-	-	-		cm <b>40</b>		cm/h	<b>2,15</b>	-
	<b>190+310</b>	-	-	-		cm	-	cm	<b>40</b>	-
	<b>79</b>	-	-	-		<b>12,5</b>	-			

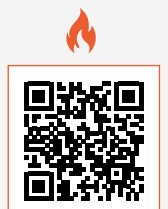

601

# 601 CON FORNO SERENELLA



Cucina a legna da 60 cm adatta a chi non ha molto spazio ma non vuole rinunciare al piacere del fuoco per riscaldare e cucinare. Oltre all'ampio focolare e alla piastra radiante in ghisa con cerchi, è presente un forno a legna posizionato sotto al focolare. È possibile incassarla tra i mobili predisponendo un pannello isolante sui fianchi.

60 cm wood-burning cooker suitable for those who don't have much space, but don't want to give up the pleasure of a fire for heating and cooking. In addition to the large fireplace and the cast iron radiant plate with rings, there is a wood-burning oven under the fireplace.

It can be fit between the furniture by placing an insulating panel on its sides.

Cuisinière à bois de 60 cm parfaite pour ceux qui n'ont pas beaucoup d'espace mais qui ne veulent pas renoncer au plaisir du feu pour se chauffer et cuisiner. En plus du grand foyer et de la plaque radiante en fonte avec cercles, elle dispose d'un four à bois placé sous le foyer.

Il est possible de l'encaster entre les meubles en plaçant un panneau isolant sur les côtés.

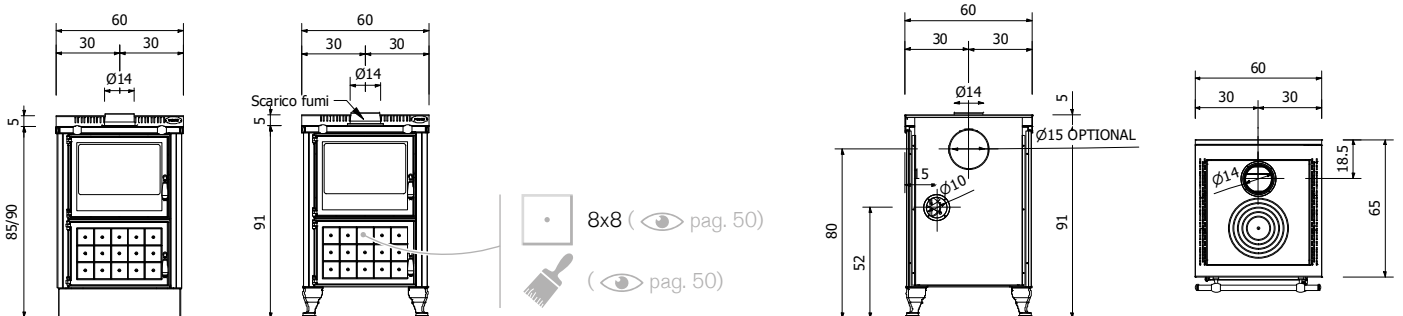

		<b>7,3</b>		-
	-	-	-	-
	-	-	-	-
	-	<b>190+310</b>	-	-
	-	<b>79</b>	-	-

		<b>197</b>		-
	-	<b>Ø 14</b>	-	-
		40  17  38	-	-
		18  41	-	-
		<b>12,5</b>		-

		<b>A</b>		-
	-	<b>★★★★</b>	-	-
	-	<b>2,15</b>	-	-
	-	<b>40</b>	-	-

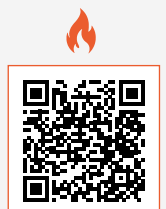

S601



# Struttura | Structure | Structure

601 CON FORNO SERENELLA

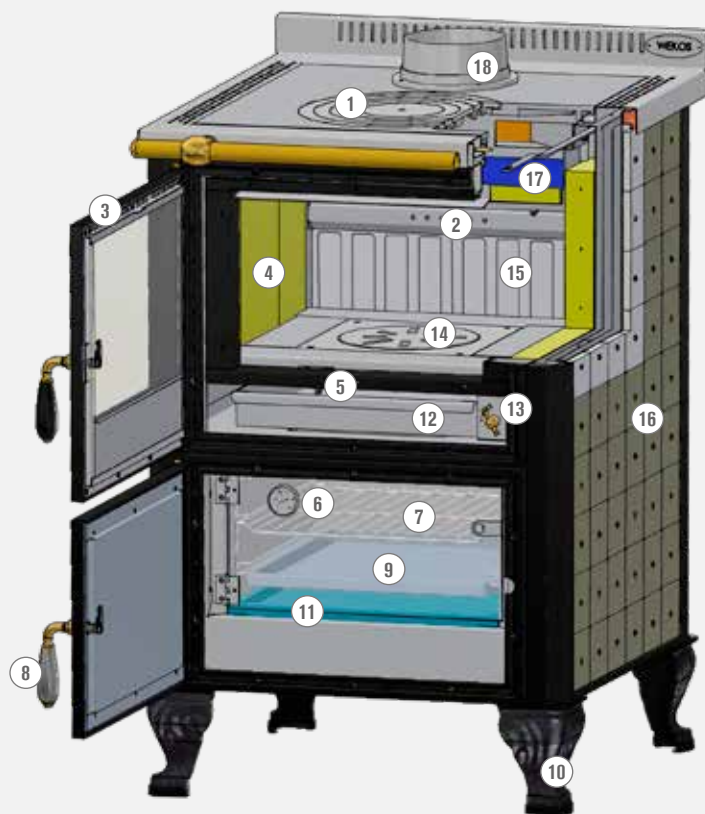

- ① Piastra in ghisa con cerchi sp. 8 mm  
Cast iron plate with rings thick. 8 mm | Plaque en fonte ép. 8 mm avec cercles
- ② Fori entrata aria terziaria  
Tertiary air inlet holes | Trous d'entrée d'air tertiaire
- ③ Fori entrata aria secondaria  
Secondary air inlet holes | Trous d'entrée d'air secondaire
- ④ Refrattari sp. 40 mm  
Refractory thick. 40 mm | Réfractaire ép. 40 mm
- ⑤ Astina scuoticenere per griglia girevole  
Ash shaker lever for rotating grill | Tirette de décendrage pour grille rotatif
- ⑥ Termometro forno a legna  
Wood oven thermometer | Thermomètre pour four a bois
- ⑦ Griglia forno in acciaio cromato  
Chromium-plated steel oven grill | Grille four en acier chromé
- ⑧ Maniglia in porcellana  
Porcelain handle | Poignée en porcelaine
- ⑨ Vassoio forno in lamiera smaltata  
Enamel plate oven shelf | Émaillé plateau four
- ⑩ Piede in ghisa h 150 mm  
Cast iron foot h. 150 mm | Pied en fonte h. 150 mm
- ⑪ Chiusura fondo forno in lamiera smaltata estraibile per pulizia sottoforno  
Enamel plate removable oven bottom panel, allows access and cleaning of under-oven section | Fermeture fond four en tôle émaillée amovible pour nettoyage sous le four
- ⑫ Cassetto cenere  
Ash drawer | Tiroir à cendres
- ⑬ Maniglia regolazione entrata aria primaria, secondaria e terziaria  
Primary, secondary and tertiary air intake control lever | Poignée de réglage pour d'entrée d'air primaire, secondaire et tertiaire
- ⑭ Griglia girevole in ghisa Ø 185 mm  
185 Ø mm cast iron rotating grill | Ø 185 mm grille rotatif
- ⑮ Ceramica refrattaria sp. 25 mm  
Refractory ceramics thick. 25 mm | Céramique réfractaire ép. 25 mm
- ⑯ Rivestimento piastrella di ceramica 8x8 cm  
8x8 cm ceramic tile cladding | Revêtement carreaux de céramique 8x8 cm
- ⑰ Asta per valvola accensione a freddo  
Bar for cold starting valve | Poignée pour vanne de démarrage à froid
- ⑱ Scarico fumi in ghisa Ø 140 mm  
140 Ø mm cast iron ring exhaust fumes outlet | Sortie de fumée en fonte Ø 140 mm

# ANTICO CASALE CLASSIC 85



Cucina a legna da 86 cm dotata di ampio focolare, capiente forno a legna e piastra radiante in ghisa con cerchi.

Molto versatile, si adatta a diversi tipi di ambienti grazie alla varietà di finiture e rivestimenti disponibili.

86 cm wood-burning cooker with large fireplace, a large wood-burning oven and a cast iron radiant plate with rings.

Very adaptable, it perfectly fits in different types of environments thanks to the variety of finishes and claddings available.

Cuisinière à bois de 86 cm équipée d'un grand foyer, un four à bois à grande capacité et une plaque radiante en fonte avec cercles.

Au style versatile, il s'adapte à différents types d'environnements grâce à la variété de finitions et de revêtements disponibles.

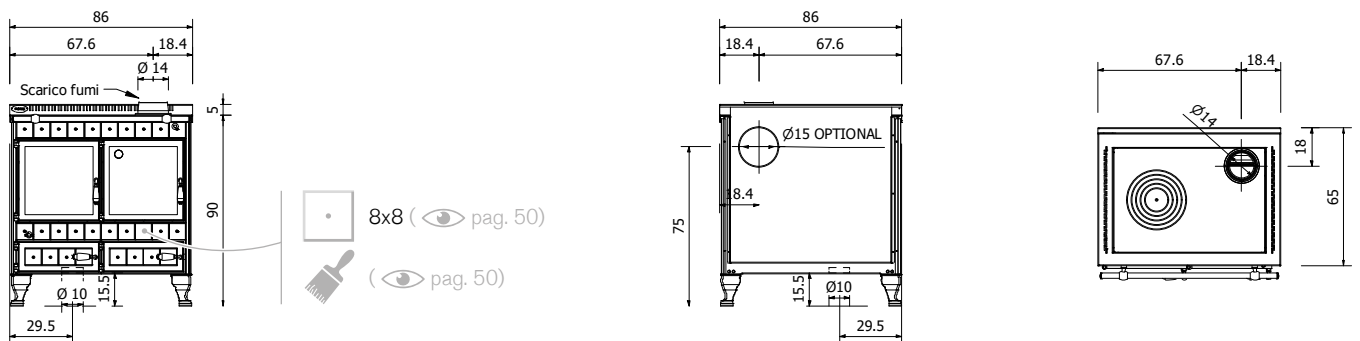

kW	9,3	-
	-	-
	-	-
	200+320	-
	82,7	-

kg	222	-
	Ø 14	-
	30	25
	52	-
	34	43
	27	-
	11	-

A+	-	-
DM 186	★★★★	-
	2,5	-
	50	-

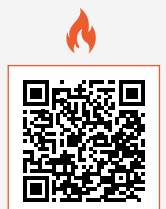

AC85

# ANTICO CASALE CLASSIC 90



Cucina a legna da 90 cm molto robusta e con ottime prestazioni di riscaldamento. Dispone di un focolare profondo, un ampio forno a legna e di una piastra radiante in ghisa con cerchi.

È disponibile anche nella versione simmetrica con scarico fumi a sinistra e nella versione termo per scaldare gli ambienti con l'acqua calda della caldaia interna in acciaio inox.







90 cm wood-burning cooker, very robust and with excellent heating performance. It features a deep fireplace, a large wood-burning oven and a cast iron radiant plate with rings.

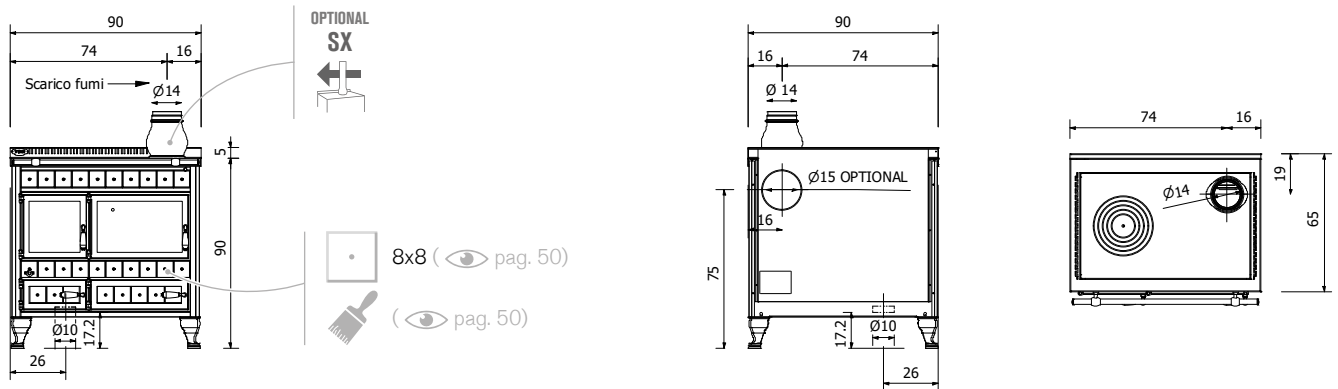





It is also available in the symmetrical version with flue gas outlet on the left and in the thermo-version, for heating rooms with hot water from the internal stainless steel boiler.





Cuisinière à bois de 90 cm, très robuste et avec d'excellentes performances de chauffage. Elle dispose d'un foyer profond, d'un grand four à bois et d'une plaque radiante en fonte avec cercles.

Elle existe également dans la version symétrique avec sortie des fumées à gauche et dans la version thermo, permettant de chauffer les pièces via l'eau chaude du bouilleur interne en acier inoxydable.



		
 kW	9,3	13,3
 kW	-	8,2
 kW	-	5,1
 m³	200÷320	280÷450
 %	82,7	85

		
 kg	249	233
 cm	Ø 14	Ø 14
 cm	25 → 51	19 → 52
 cm	26 → 44	26 → 44
 Pa	11	12

		
 A+	A+	A+
DM 186	★★★★	★★★
 kg/h	2,5	3,6
 cm	50	50

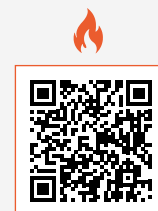

AC90



TAC90



# Struttura | Structure | Structure

TERMOCUCINA ANTICO CASALE CLASSIC 100

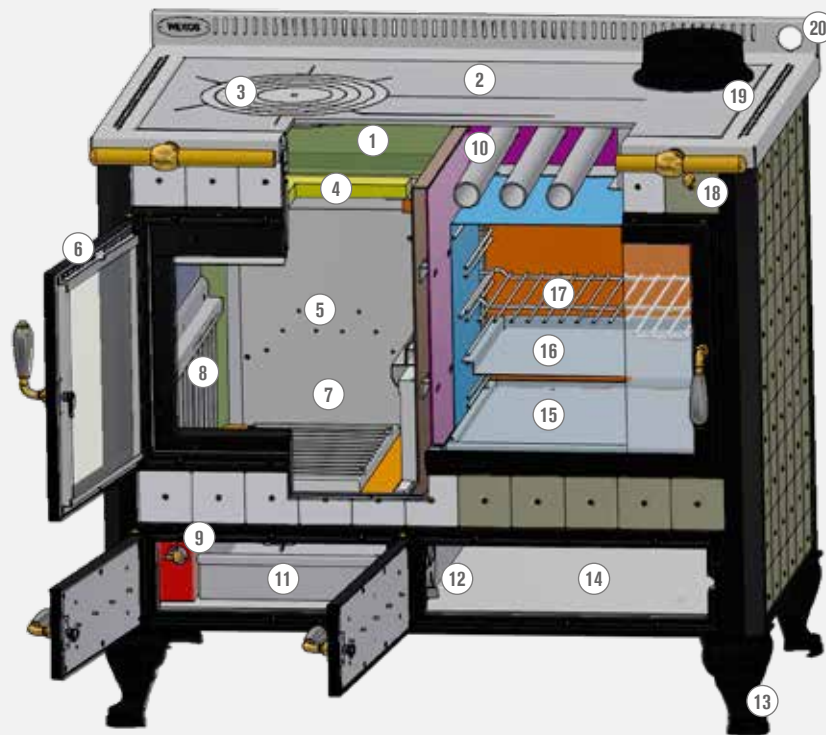

- 1 Caldaia in acciaio inox 304 sp. 30/10 (garanzia 10 anni)  
Stainless steel 304 boiler thick. 30/10 (10 years warranty) | Bouilleur acier inox 304 ép. 30/10 (10 ans de garantie)
- 2 Piastra in acciaio sp. 8 mm  
Steel plate thick. 8 mm | Plaque en acier ép. 8 mm
- 3 Cerchi in ghisa  
Cast iron rings | Cercles en fonte
- 4 Deviatore fumi  
Smoke diverter | Inverseur de fumée
- 5 Fori entrata aria terziaria  
Tertiary air inlet holes | Trous d'entrée d'air tertiaire
- 6 Fori entrata aria secondaria  
Secondary air inlet holes | Trous d'entrée d'air secondaire
- 7 Piastra posteriore in ghisa  
Cast iron back plate | Plaque arrière en fonte
- 8 Ceramica refrattaria sp. 25 mm  
Refractory ceramics thick. 25 mm | Céramique réfractaire ép. 25 mm
- 9 Asta per valvola automatica aria primaria e secondaria  
Bar for automatic valve for primary and secondary air | Commande de réglage automatique d'air primaire et secondaire
- 10 Tubi caldaia in acciaio inox  
Stainless steel boiler pipes | Tubes bouilleur en acier inox
- 11 Cassetto cenere  
Ash drawer | Tiroir à cendres
- 12 Valvola aggiuntiva aria primaria manuale  
Additional manual valve for primary air | Vanne supplémentaire pour air primaire manuel
- 13 Piede in ghisa h 150 mm  
Cast iron foot h. 150 mm | Pied en fonte h. 150 mm
- 14 Scaldavivande  
Dish warming compartment | Compartiment chauffe-plats
- 15 Chiusura fondo forno in lamiera smaltata estraibile per pulizia sotto forno  
Enamelled plate removable oven bottom panel, allows access and cleaning of under-oven section | Fermeture fond four en tôle émaillée amovible pour nettoyage sous le four
- 16 Vassoio forno in lamiera smaltata  
Enamelled plate oven shelf | Émaillé plateau four
- 17 Griglia forno in acciaio cromato  
Chromium-plated steel oven grill | Grille four en acier chromé
- 18 Pomello per apertura valvola accensione a freddo  
Cold starting valve opening knob | Commande d'ouverture de la valve de démarrage à froid
- 19 Scarico fumi in ghisa Ø 150 mm  
150 Ø mm cast iron flue | Sortie de fumée en fonte Ø 150 mm
- 20 Termometro temperatura acqua in uscita  
Outlet water temperature thermometer | Thermomètre de sortie d'eau

# ANTICO CASALE CLASSIC 100









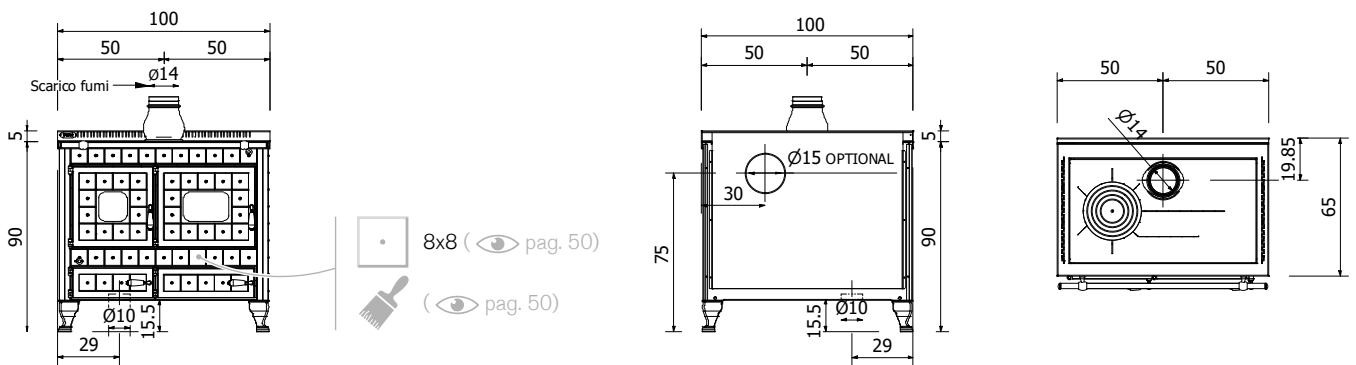





Cucina a legna da 100 cm con ottime prestazioni di riscaldamento e di cottura grazie all'ampio focolare, alla grande piastra in acciaio di grosso spessore e al capiente forno a legna. È disponibile anche nella versione termo per scaldare gli ambienti con l'acqua calda della caldaia interna in acciaio inox.





100 cm wood-burning cooker with excellent heating and cooking performance thanks to its large fireplace, its large and thick steel plate, as well as its capacious wood-fired oven. It is also available in the thermo-version, to heat environments with hot water from the internal stainless steel boiler.

Cuisinière à bois de 100 cm avec d'excellentes performances de chauffe et de cuisson grâce au foyer spacieux, à la grande plaque en acier épaisse et à l'ample four à bois. Elle est également disponible dans la version thermo permettant de chauffer les pièces via l'eau chaude du bouilleur interne en acier inoxydable.



		
 kW	9,3	13,3
 kW	-	8,2
 kW	-	5,1
 m³	200÷320	280÷450
$\eta$ %	82,7	85

		
 kg	258	273
 cm	Ø 14	Ø 15
 cm	30 25 52	33 30 50
 cm	32 43	31 45
 Pa	11	12

		
 A+	A+	A+
DM 186	★★★★	★★★
 kg/h	2,5	3,6
 cm	50	50

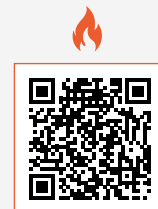

AC100



TAC100



Termocucina Antico Casale Classic 100 installata presso il B&B Campo Base - Carone (BG)

# MONTE ROSA 90



Cucina a legna da 90 cm impreziosita dal particolare rivestimento in pietra serpentino bocciardata e dalle finiture in rame. Molto robusta e con ottime prestazioni di riscaldamento e di cottura, è particolarmente adatta ad ambienti rustici e di montagna. È disponibile anche nella versione simmetrica con scarico fumi a sinistra e nella versione termo per scaldare gli ambienti con l'acqua calda della caldaia interna in acciaio inox.

90 cm wood-burning cooker embellished with a particular bush-hammered serpentine stone cladding and copper finishes. Very robust and with excellent heating and cooking performance, it is particularly suitable for rustic and mountain environments. It is also available in the symmetrical version with flue gas outlet on the left and in the thermo-version for heating rooms with hot water from the internal stainless steel boiler.

Cuisinière à bois de 90 cm enrichie par le revêtement particulier en pierre serpentine bouchardée et les finitions en cuivre. Très robuste et dotée d'excellentes performances de chauffe et de cuisson, elle s'intègre parfaitement dans les environnements rustiques et montagnards. Elle est également disponible en version symétrique, avec sortie des fumées à gauche, ainsi qu'en version thermo, permettant de chauffer les pièces via l'eau chaude du bouilleur interne en acier inoxydable.

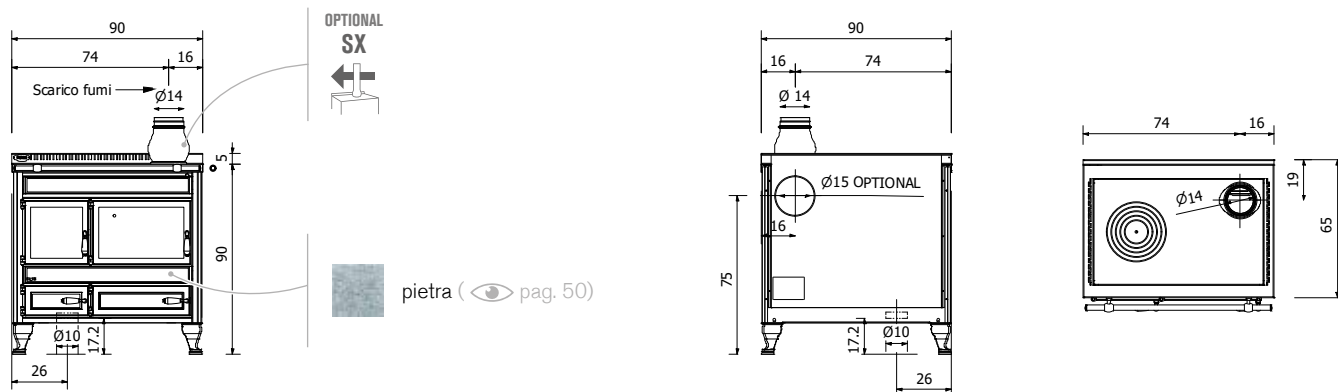

kW	9,3	13,3
kW	-	8,2
kW	-	5,1
m³	200÷320	280÷450
%	82,7	85

kg	275	271
cm	Ø 14	Ø 14
cm	25 → 51	19 → 52
cm	26 → 44	26 → 44
Pa	11	12

A+	A+	A+
DM 186	★★★★	★★★
kg/h	2,5	3,6
cm	50	50



MR90

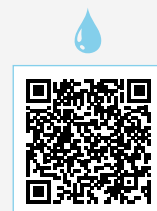

TMR90



# HARMONY 90









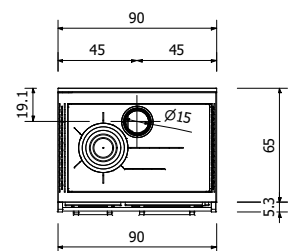
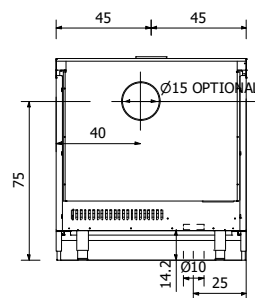
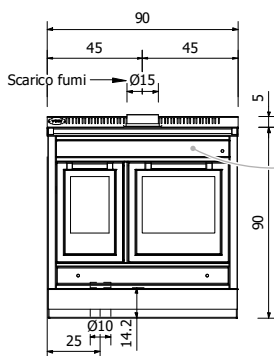







Cucina a legna da 90 cm che riproduce in stile moderno la tradizionale cucina a legna di un tempo, regalando il fascino del fuoco e dei gustosi piatti cucinati in casa. La struttura molto robusta e la piastra di cottura in acciaio di grosso spessore sono garanzia di lunga durata. È disponibile anche nella versione termo per scaldare gli ambienti con l'acqua calda della caldaia interna in acciaio inox.





90 cm wood-burning cooker that reproduces in a modern style the traditional wood-burning cooker from the past, providing the charm of the fire and tasty home-cooked dishes. Its extremely robust structure and thick steel cooking plate are a guarantee of long life. It is also available in the thermo-version to heat rooms with hot water from the internal stainless steel boiler.

Cuisinière à bois de 90 cm, qui revisite la cuisinière traditionnelle d'autrefois dans un style moderne, tout en préservant le charme du feu et des savoureux plats faits maison. Sa structure très robuste et sa plaque de cuisson en acier épais garantissent une longue durée de vie. Elle est également disponible dans la version thermo pour chauffer les pièces avec l'eau chaude provenant du bouilleur interne en acier inoxydable.



		
 kW	9,3	13,3
 kW	-	8,2
 kW	-	5,1
 m³	200÷320	280÷450
 %	82,7	85

		
 kg	231	263
 cm	Ø 15	Ø 15
 cm	25 25 51 19	25 25 52 19
 cm	31 31 45 45	31 31 45 45
 Pa	11	12

		
 A+	A+	A+
DM 186	★★★★	★★★
 kg/h	2,5	3,6
 cm	50	50

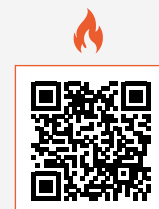

CH90

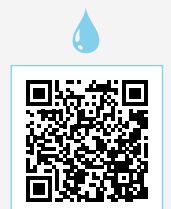

TCH90





# CUCINE E TERMOCUCINE COMBinate

DUAL SYSTEM  
COOKERS AND THERMO  
COOKERS

CUISINIÈRES COMBINÉES  
ET CUISINIÈRES BOUILLEUR

# 120 LGE



Combinazione tra la cucina a legna da 60 cm e la cucina di cottura da 60 cm. È caratterizzata da un forno elettrico multifunzione e un piano cottura 4 fuochi gas o induzione. Può contenere ceppi di legna di grosse dimensioni grazie all'ampio focolare. Possibilità di incasso predisponendo un pannello isolante sui fianchi.

Combination of the 60 cm wood-burning cooker and the 60 cm cooking range, it features a multifunction electric oven and a 4-burner gas or induction hob. It can accommodate large logs thanks to its wide fireplace. It can be fit between the furniture by placing insulating panels on its sides.

Combinaison entre la cuisinière à bois 60 cm et la cuisinière 60 cm. Elle se caractérise par un four électrique multifonction et une plaque de cuisson ayant 4 feux à gaz ou induction. Son grand foyer permet de recevoir de grosses bûches de bois. Possibilité d'encastrement en prévoyant un panneau isolant sur les côtés.

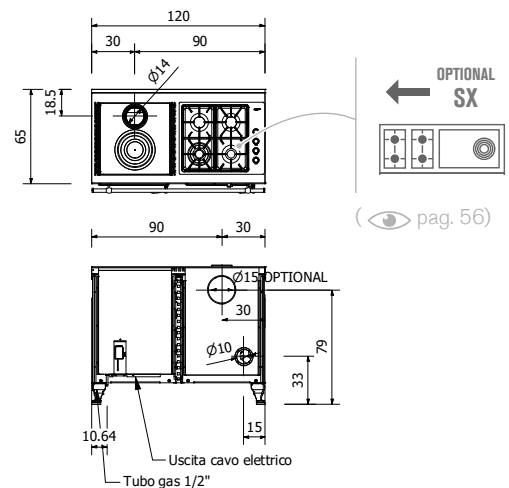
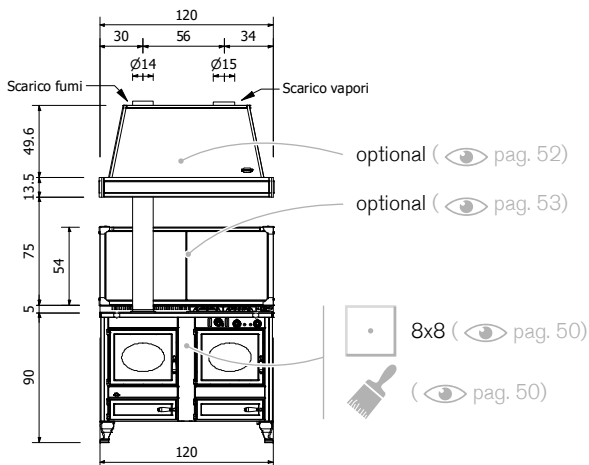

<b>7,3</b>	-	
-	-	
-	-	
	<b>190+310</b>	-
	<b>79</b>	-

<b>278</b>	-	
<b>Ø 14</b>	-	
<b>40</b>	<b>28</b>	<b>38</b>
-	-	
<b>12,5</b>	-	

<b>A</b>	-	
<b>DM 186</b>	<b>★★★★</b>	-
<b>2,15</b>	-	
<b>40</b>	-	

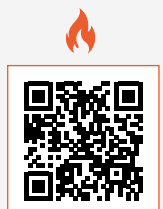

120

# 120 LGE/F LOBELIA



Combinazione tra la cucina a legna e la cucina di cottura entrambe da 60 cm. In soli 120 cm si può trovare tutto l'essenziale per chi ama cucinare e riscaldare con la legna: ampio focolare, piastra radiante in ghisa, forno a legna, forno elettrico multifunzione e top cottura a gas o induzione. Possibilità di incasso predisponendo un pannello isolante sui fianchi.

Combination of a wood-burning cooker and a cooking range, both 60 cm. In just 120 cm it has everything essential for those who love cooking and heating with wood: large fireplace, cast iron radiant plate, wood-burning oven, multifunction electric oven and gas or induction hob. It can be fit between the furniture by placing insulating panels on its sides.

Combinaison entre la cuisinière à bois et la cuisinière, tous deux de 60 cm. En seulement 120 cm, vous trouverez tous les indispensables pour ceux qui aiment cuisiner et chauffer la maison au bois : un grand foyer, une plaque radiante en fonte, un four à bois, un four électrique multifonction et une plaque de cuisson à gaz ou à induction. Possibilité d'encastrement en prévoyant un panneau isolant sur les côtés.

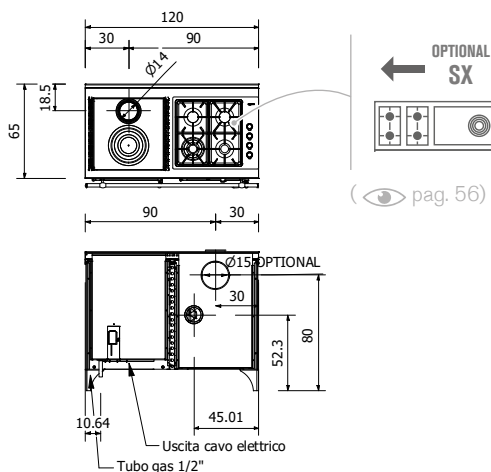
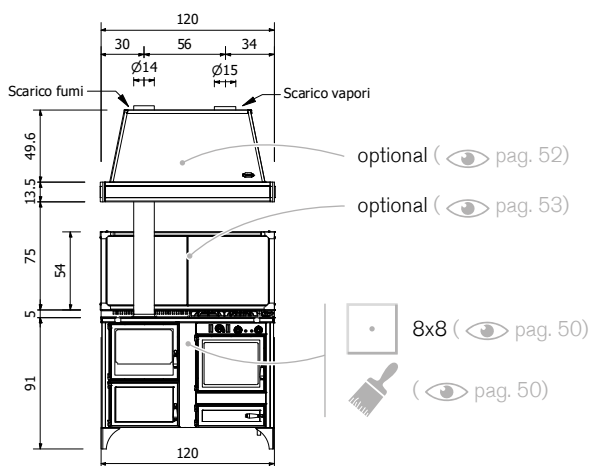

	<b>7,3</b>	-
	-	-
	-	-
	<b>190+310</b>	-
	<b>79</b>	-

	<b>285</b>	-
	<b>Ø 14</b>	-
	40 <sup>17</sup> <sub>38</sub>	-
	37 <sup>18</sup> <sub>41</sub>	-
	<b>12,5</b>	-

	<b>A</b>	-
	<b>★★★★</b>	-
	<b>2,15</b>	-
	<b>40</b>	-

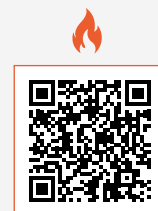

L120

# 135 LGE VIOLETTA



Cucina combinata composta da una cucina a legna da 60 cm e una cucina di cottura da 75 cm. Si contraddistingue per l'ampio focolare e il capiente forno elettrico multifunzione oltre che per l'ampia scelta del top cottura a gas o induzione. Possibilità di incasso predisponendo un pannello isolante sui fianchi.

Combined cooker consisting of a 60cm wood-burning cooker and a 75cm cooking range. It stands out for its large fireplace and a wide multifunction electric oven, as well as the broad range of gas or induction hobs. It can be fit between the furniture by placing insulating panels on its sides.

Cuisinière combinée composée d'une cuisinière à bois de 60 cm et d'une cuisinière de 75 cm. Elle se distingue par son foyer spacieux et son grand four électrique multifonction ainsi que par le large choix de plaques de cuisson à gaz ou à induction. Possibilité d'encastrement en prévoyant un panneau isolant sur les côtés.

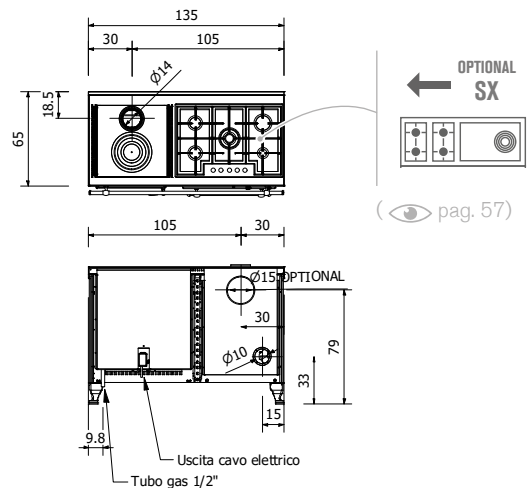
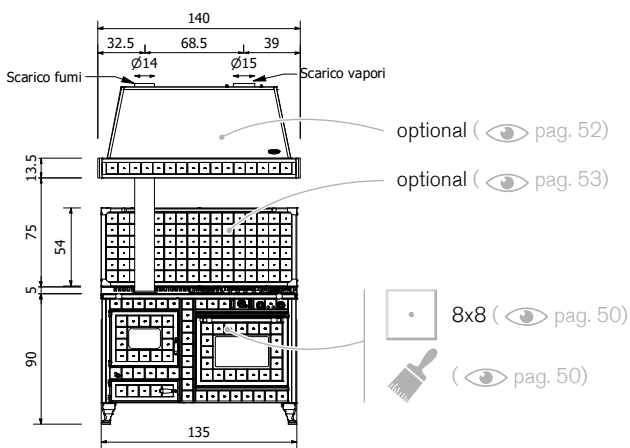

kW	7,3	-
	kW	-
	kW	-
	m <sup>3</sup>	190+310
	%	79

kg	300	-
	cm	Ø 14
	cm	40
	cm	28
	cm	38
	cm	-
	Pa	12,5

	A	-
	DM 186	★★★★
	kg/h	2,15
	cm	40

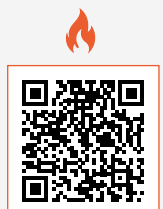

V135



Cucina combinata 135/F Arnica installata presso Quinta da Mata de Baixo, Dornes - Portogallo

# 135 LGE/F ARNICA



Combinazione tra la cucina a legna da 60 cm e la cucina di cottura da 75 cm. Completa di forno a legna e forno elettrico multifunzione, con i suoi 135 cm si adatta facilmente a diverse soluzioni di spazi. Le varie possibilità di top cottura, finiture e rivestimenti permettono di personalizzarla secondo i propri gusti. Possibilità di incasso predisponendo un pannello isolante sui fianchi.

Combination of the 60 cm wood-burning cooker and the 75 cm cooking range. Complete with wood-burning oven and multifunction electric oven, with its 135 cm, it easily adapts to different space solutions. The various options for cooking hobs, finishes and claddings allow you to customize it according to your tastes. It can be fit between the furniture by placing insulating panels on its sides.

Combinaison entre la cuisinière à bois de 60 cm et la cuisinière de 75 cm. Equipée de four à bois et de four électrique multifonction, avec ses 135 cm, elle s'adapte facilement à plusieurs solutions d'espace. Les différentes options de plaques de cuisson, de finitions et de revêtements vous permettent de la personnaliser selon vos goûts. Possibilité d'encastrement en prévoyant un panneau isolant sur les côtés.

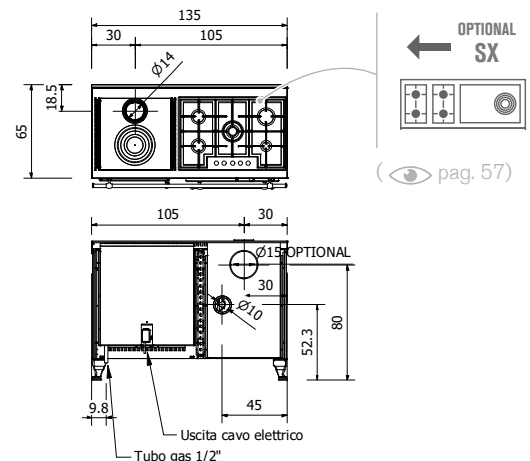
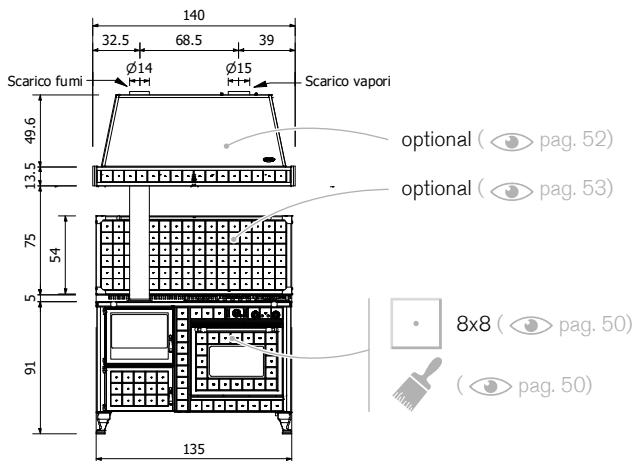

<b>7,3</b> kW	-	
- kW	-	
- kW	-	
<b>190+310</b> m <sup>3</sup>	-	
<b>79</b> %	-	

<b>315</b> kg	-	
<b>Ø 14</b> cm	-	
<b>40</b> cm	<b>17</b> cm	<b>38</b> cm
<b>37</b> cm	<b>18</b> cm	<b>41</b> cm
<b>12,5</b> Pa	-	

<b>A</b>	-	
DM 186	★★★★	-
<b>2,15</b> kg/h	-	
<b>40</b> cm	-	

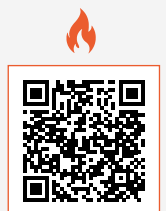

A135



# ANTICO CASALE 360 LGE



Cucina combinata che coniuga in un'unica composizione cucina a legna, forno elettrico multifunzione e piano cottura a gas o induzione. Disponibile anche nella versione termo.

Combined cooker featuring a wood-burning cooker, a multifunction electric oven and a gas or induction hob in a single composition. Also available in the thermo-version.

Cuisinière combinée qui assemble une cuisinière à bois, un four électrique multifonction et une plaque de cuisson à gaz ou à induction dans une seule composition. Également disponible en version thermo.

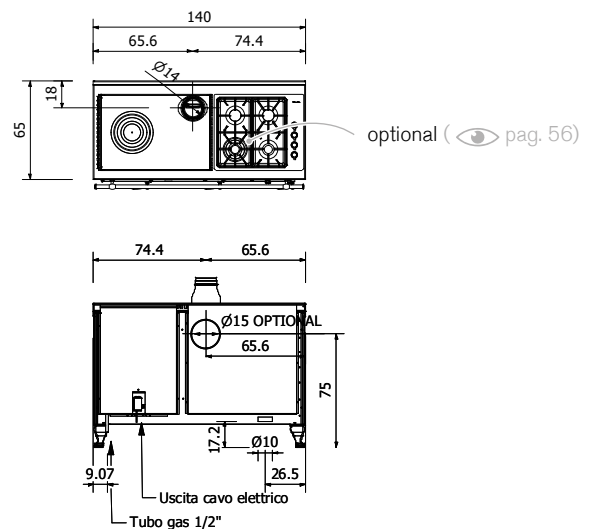
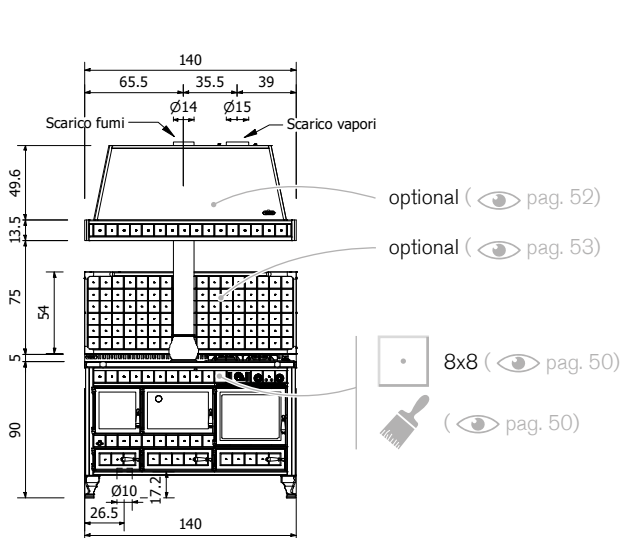

kW	9,3	13,3
kW	-	8,2
kW	-	5,1
m³	200÷320	280÷450
%	82,7	85

kg	326	313
cm	Ø 14	Ø 14
cm	25 → 51	19 → 52
cm	26 → 44	26 → 44
Pa	11	12

A+	A+	A+
DM 186	★★★★	★★★
kg/h	2,5	3,6
cm	50	50

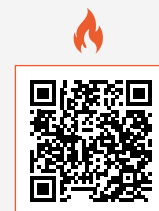

AC360

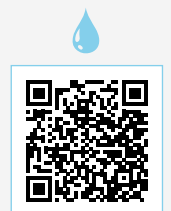

TAC360



# ANTICO CASALE 150 LGE









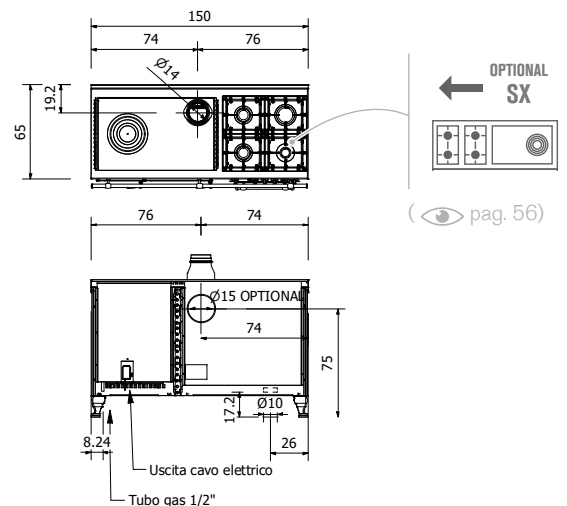
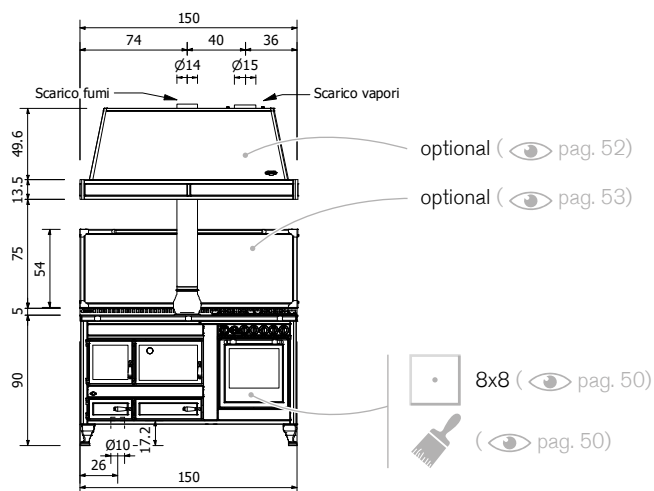







Combinazione tra la cucina a legna da 90 cm e la cucina di cottura da 60 cm. La vasta scelta dei top cottura, insieme alla varietà di finiture e rivestimenti, permettono di realizzare la cucina da riscaldamento e cottura più adatta alle proprie esigenze. Disponibile anche nella versione termo.





Combination of the 90 cm wood-burning cooker and the 60 cm cooker. The wide range of cooking hobs, together with the variety of finishes and claddings, allow you to create the heating and cooking range that best suits your needs. Also available in the thermo-version.

Combinaison entre la cuisinière à bois de 90 cm et la cuisinière de 60 cm. Le large choix de plaques de cuisson, ainsi que la diversité des finitions et des revêtements, vous permet de créer l'appareil de chauffage et de cuisson le mieux adapté à vos besoins. Également disponible en version thermo.



		
 kW	9,3	13,3
 kW	-	8,2
 kW	-	5,1
 m³	200÷320	280÷450
 %	82,7	85

		
 kg	360	355
 cm	Ø 14	Ø 14
 cm	25 → 51	19 → 52
 cm	26 → 44	26 → 44
 Pa	11	12

		
 A+	A+	A+
DM 186	★★★★	★★★
 kg/h	2,5	3,6
 cm	50	50

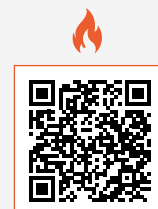

AC150

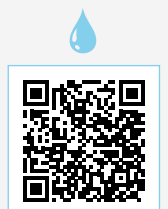

TAC150



# ANTICO CASALE 160 LGE



Cucina combinata che nasce dall'unione della cucina a legna da 100 cm e della cucina di cottura da 60 cm. Completa di forno elettrico multifunzione e di un top personalizzabile tra diversi moduli di cottura a gas o induzione. Finiture e rivestimento a scelta fra le varie soluzioni proposte. Disponibile anche nella versione termo.

Combined cooker resulting from the union of the 100 cm wood-burning cooker and the 60 cm cooking range. Complete with multifunction electric oven and a customizable hob to be selected among different gas or induction cooking modules. Finishes and cladding to choose from the various solutions proposed. Also available in the thermo-version.

Cuisinière combinée résultant de l'association d'une cuisinière à bois de 100 cm et d'une cuisinière de 60 cm. Équipée d'un four électrique multifonction et d'une plaque de cuisson personnalisable, avec différents modules au choix : gaz ou induction. Finitions et revêtements disponibles parmi plusieurs options proposées. Également disponible en version thermo.

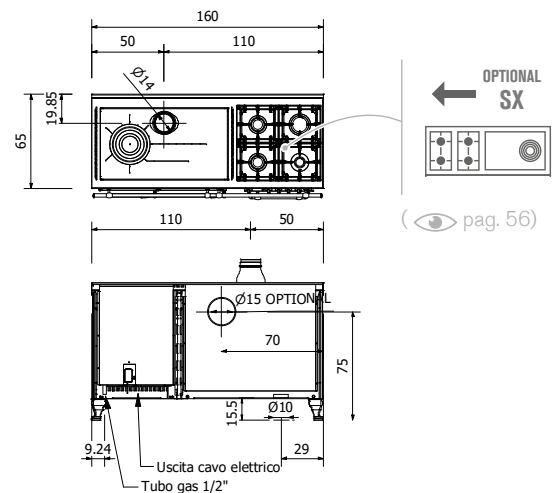
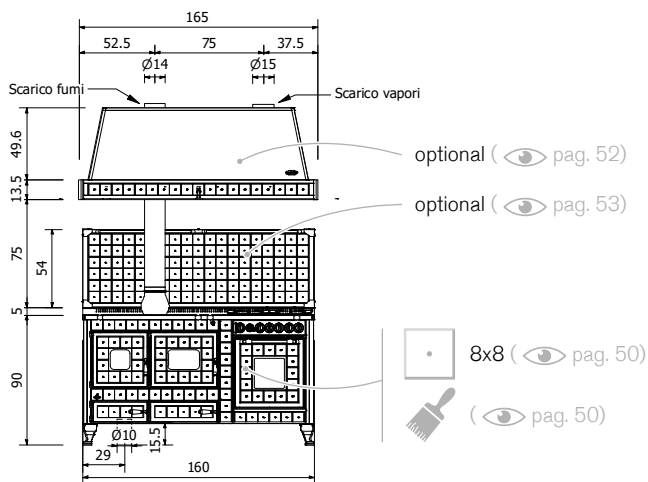

kW	9,3	13,3
kW	-	8,2
kW	-	5,1
m³	200÷320	280÷450
%	82,7	85

kg	368	360
cm	Ø 14	Ø 15
cm	30 → 25 → 52	33 → 30 → 50
cm	32 → 43	31 → 45
Pa	11	12

A+	A+	A+
DM 186	★★★★	★★★
kg/h	2,5	3,6
cm	50	50

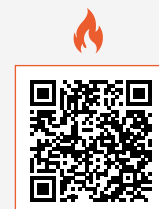

AC160

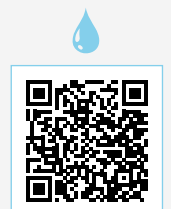

TAC160

# ANTICO CASALE 165 LGE









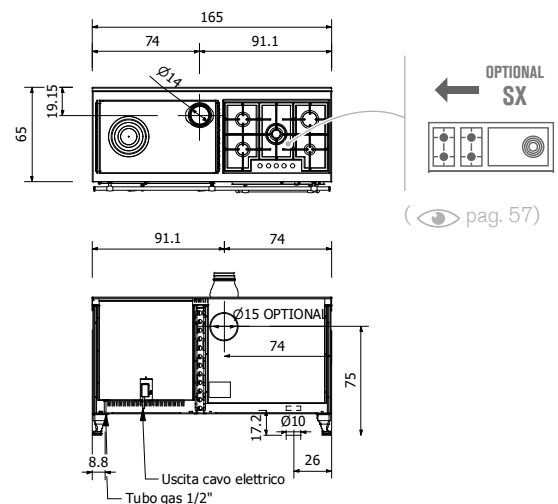
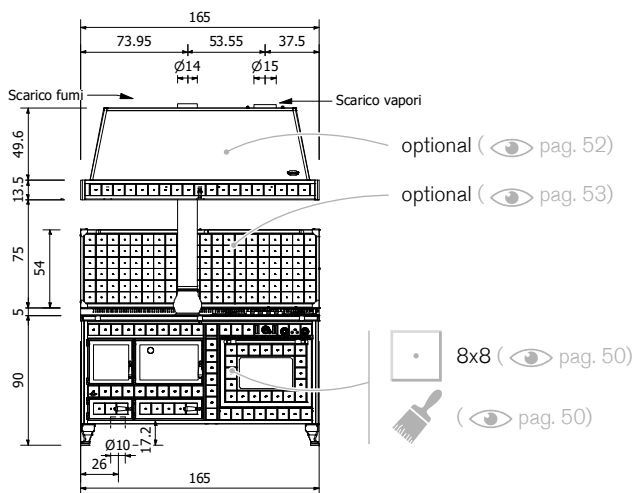















Combinazione tra la cucina a legna da 90 cm e la cucina di cottura da 75 cm dotata di un capiente forno elettrico multifunzione e di un top personalizzabile nelle varie soluzioni gas o induzione. Disponibile anche nella versione termo.

Combination of the 90 cm wood-burning cooker and the 75 cm cooking range equipped with a large multifunction electric oven and a customizable hob with various gas or induction solutions. Also available in the thermo-version.

Combinaison d'une cuisinière à bois de 90 cm et d'une cuisinière de 75 cm, équipée d'un grand four électrique multifonction et d'une plaque de cuisson personnalisable dans différentes solutions à gaz ou à induction. Également disponible en version thermo.



										
 kW	9,3	13,3	 kg	382	377	 A+	A+			
 kW	-	8,2	 cm	Ø 14	Ø 14	DM 186	★★★★	★★★	AC165	TAC165
 kW	-	5,1	 cm	25 25 51 19 51 52	25 19 52 52	 kg/h	2,5	3,6		
 m³	200÷320	280÷450	 cm	26 26 44 44	26 26 44 44	 cm	50	50		
 %	82,7	85	 Pa	11	12					



# ANTICO CASALE 175 LGE









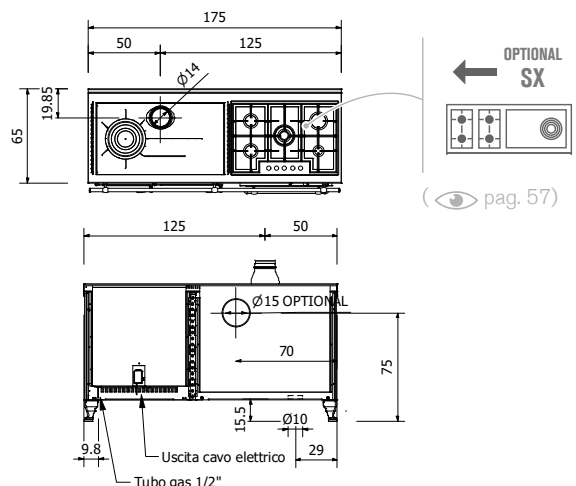
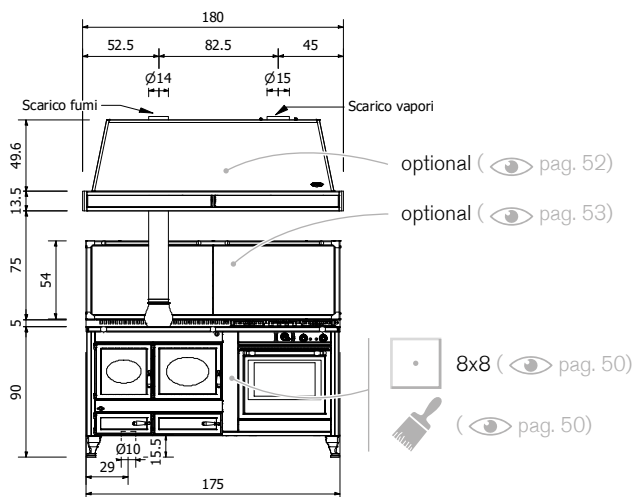







Cucina combinata che nasce dall'unione della cucina a legna da 100 cm e della cucina di cottura da 75 cm. L'ampia scelta dei rivestimenti disponibili, unitamente alla varietà di finiture e del top personalizzabile, rendono questa cucina adatta a diversi stili di ambiente. Disponibile anche nella versione termo.





Combined cooker born from the union of the 100 cm wood-burning cooker and the 75 cm cooking range. The wide choice of available claddings together with the variety of finishes and customizable tops make this kitchen suitable for different styles of environments. Also available in the thermo-version.

Cuisinière combinée issue de l'association d'une cuisinière à bois de 100 cm et d'une cuisinière de 75 cm. Le large choix de revêtements, ainsi que la variété de finitions et de plaques personnalisables, rendent cette cuisinière adaptée à divers styles d'intérieurs. Également disponible en version thermo.



		
 kW	9,3	13,3
 kW	-	8,2
 kW	-	5,1
 m³	200÷320	280÷450
 %	82,7	85

		
 kg	364	370
 cm	Ø 14	Ø 15
 cm	30 → 25 → 52	33 → 30 → 50
 cm	32 → 38 → 43	31 → 35 → 45
 Pa	11	12

		
 A+	A+	A+
DM 186	★★★★	★★★
 kg/h	2,5	3,6
 cm	50	50

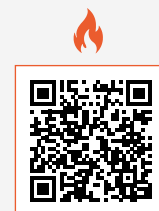

AC175

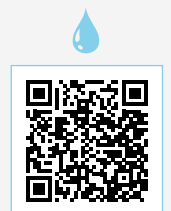

TAC175



# Struttura | Structure | Structure

ANTICO CASALE 175 LGE

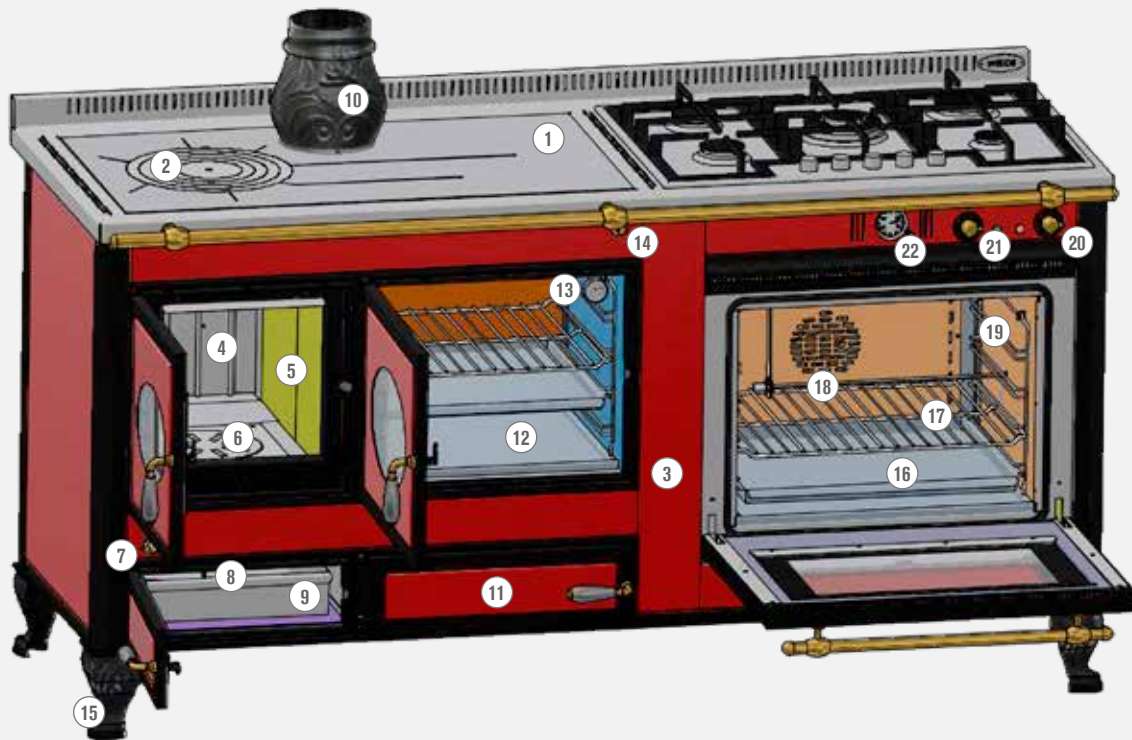

- ① Piastra in acciaio sp. 8 mm  
Steel plate thick. 8 mm | Plaque en acier ép. 8 mm
- ② Cerchi in ghisa  
Cast iron rings | Cercles en fonte
- ③ Rivestimento pannelli smaltati  
Enamelled panels cladding | Revêtement en panneaux émaillés
- ④ Piastra posteriore in ghisa  
Cast iron back plate | Plaque arrière en fonte
- ⑤ Refrattari laterali sp. 50 mm  
Side refractory thick. 50 mm | Réfractaires latérales ép. 50 mm
- ⑥ Griglia girevole in ghisa Ø 185 mm  
185 Ø mm cast iron rotating grill | Ø 185 mm grille rotatif
- ⑦ Maniglia regolazione aria primaria e secondaria  
Primary and secondary air intake control lever | Poignée de réglage pour l'air primaire et secondaire
- ⑧ Astina scuoticenere per griglia girevole  
Ash shaker lever for rotating grill | Tirette de décrochage pour grille rotatif
- ⑨ Cassetto cenere  
Ash drawer | Cendrier
- ⑩ Scarico fumi in ghisa lavorato Ø 140 mm | Machined cast iron flue 140 Ø mm | Sortie de fumée en fonte usinée Ø 140 mm
- ⑪ Scaldavivande  
Dish warming compartment | Compartiment chauffe-plats
- ⑫ Chiusura fondo forno in lamiera smaltata estraibile per pulizia sottoforno  
Enamelled plate removable oven bottom panel, allows access and cleaning of under-oven section | Fermeture fond four en tôle émaillée amovible pour nettoyage sous le four
- ⑬ Termometro forno a legna  
Wood oven thermometer | Thermomètre pour four a bois
- ⑭ Pomello per apertura valvola accensione a freddo  
Cold starting valve opening knob | Commande d'ouverture de la valve de démarrage à froid
- ⑮ Piede in ghisa h 150 mm  
Cast iron foot h. 150 mm | Pied en fonte h. 150 mm
- ⑯ Vassoio forno elettrico  
Electric oven shelf | Plateau pour four électrique
- ⑰ Griglia forno elettrico  
Electric oven grill | Grille pour four électrique
- ⑱ Girarrosto  
Rotisserie | Rôtissoire
- ⑲ Supporto vassoio e griglia removibile  
Removable grill and shelf support | Support amovible pour plateau et grille
- ⑳ Termostato  
Thermostat | Thermostat
- ㉑ Commutatore  
Commutator | Commutateur
- ㉒ Programmatore  
Programmer | Programmeur

# ANTICO CASALE 180 LGE



Combinazione tra la cucina a legna da 90 cm e la cucina di cottura da 90 cm. Il grande forno elettrico multifunzione e la vasta scelta dei top cottura, insieme alla varietà di finiture e rivestimenti, permettono di creare in base alle proprie esigenze la propria cucina ideale. Disponibile anche nella versione thermo.

Combination of the 90 cm wood-burning cooker and the 90 cm cooking range. The large multifunction electric oven and the wide choice of cooking hobs, together with the variety of finishes and claddings, allow you to create your ideal cooker based on your needs. Also available in the thermo-version.

Combinaison d'une cuisinière à bois de 90 cm et d'une cuisinière de 90 cm. Le grand four électrique multifonction, le large choix de plaques de cuisson, ainsi que la variété de finitions et de revêtements, vous permettront de créer votre cuisinière idéale selon vos besoins. Également disponible en version thermo.

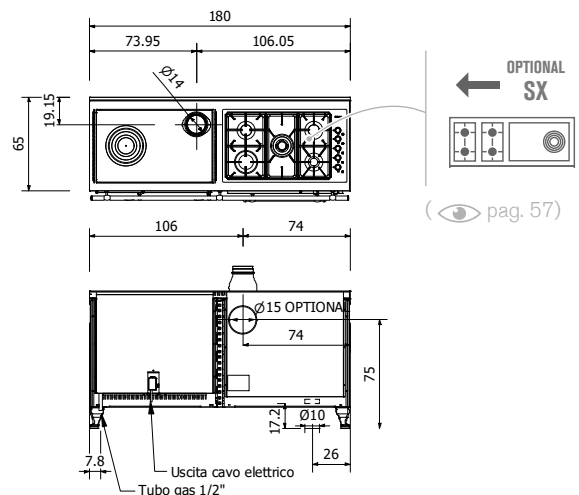
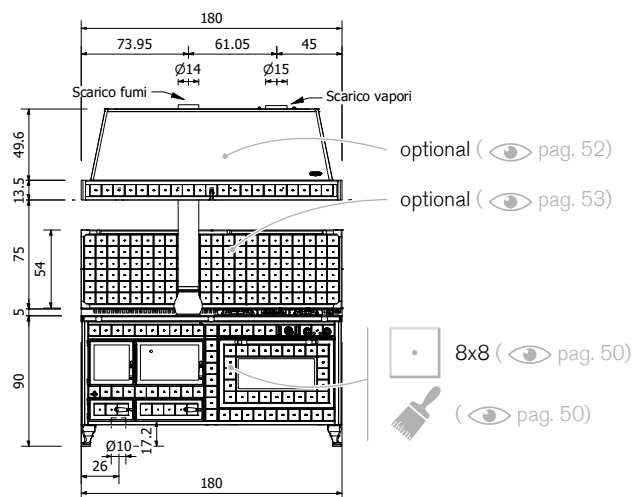

	9,3	13,3
kW	9,3	13,3
kW	-	8,2
kW	-	5,1
m <sup>3</sup>	200÷320	280÷450
η %	82,7	85

	419	403
kg	419	403
cm	Ø 14	Ø 14
cm	25 / 51	19 / 52
cm	26 / 44	26 / 44
Pa	11	12

	A+	A+
DM 186	★★★★	★★★
kg/h	2,5	3,6
cm	50	50

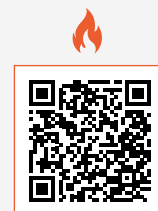

AC180



TAC180

# ANTICO CASALE 190 LGE



Cucina combinata che nasce dall'unione della cucina a legna da 100 cm e della cucina di cottura da 90 cm. Il top si può personalizzare scegliendo tra diverse soluzioni. Dispone di un grande forno elettrico multifunzione e di un ampio forno a legna. Ideale per case di campagna in stile Country o Provenzale, ma adatta a tutti gli ambienti. Disponibile anche nella versione thermo.

Combined cooker born from the union of the 100 cm wood-burning cooker and the 90 cm cooking range. The top can be customized by choosing among different solutions. It has a large multifunction electric oven and a large wood oven. Ideal for country houses in Country or Provençal style, yet suitable for all environments. Also available in the thermo-version.

Cuisinière combinée issue de l'association d'une cuisinière à bois de 100 cm et d'une cuisinière de 90 cm. La plaque de cuisson est personnalisable, avec plusieurs options au choix. Elle est équipée d'un grand four électrique multifonction et d'un grand four à bois. Idéale pour les maisons de campagne au style campagnard ou provençal, mais adaptée à tous les environnements. Également disponible en version thermo.

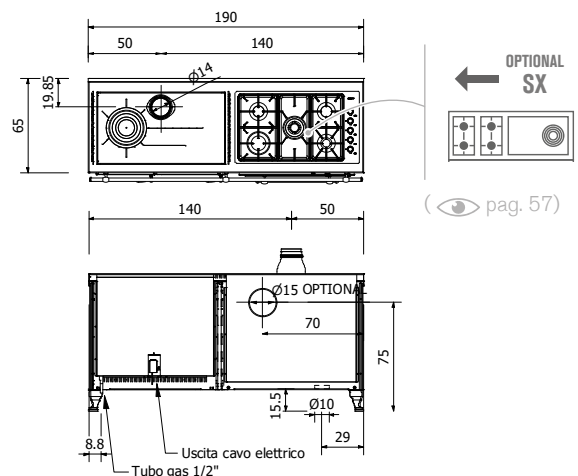
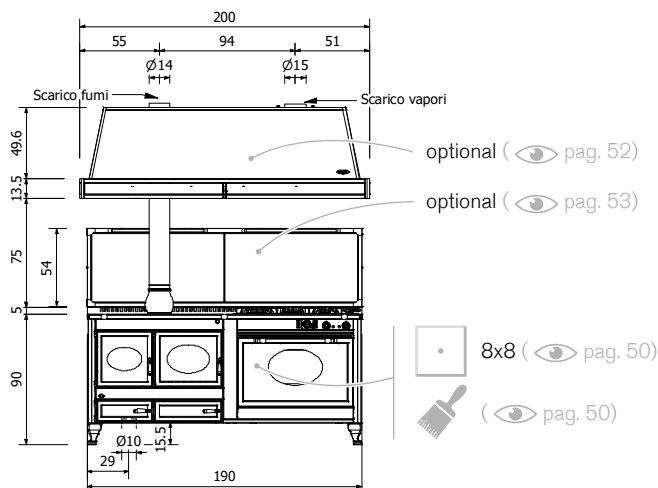

kW	9,3	13,3
kW	-	8,2
kW	-	5,1
m³	200÷320	280÷450
%	82,7	85

kg	370	405
cm	Ø 14	Ø 15
cm	30 → 25 → 52	33 → 30 → 50
cm	32 → 43	31 → 45
Pa	11	12

A+	A+	A+
DM 186	★★★★	★★★
kg/h	2,5	3,6
cm	50	50

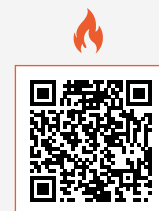

AC190

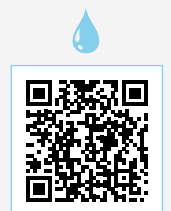

TAC190

# MONTE ROSA 360









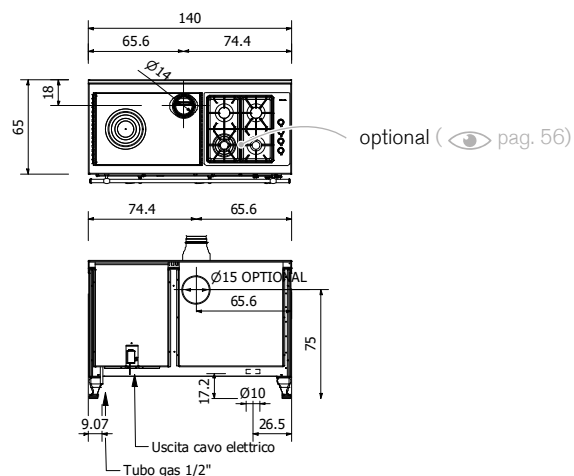
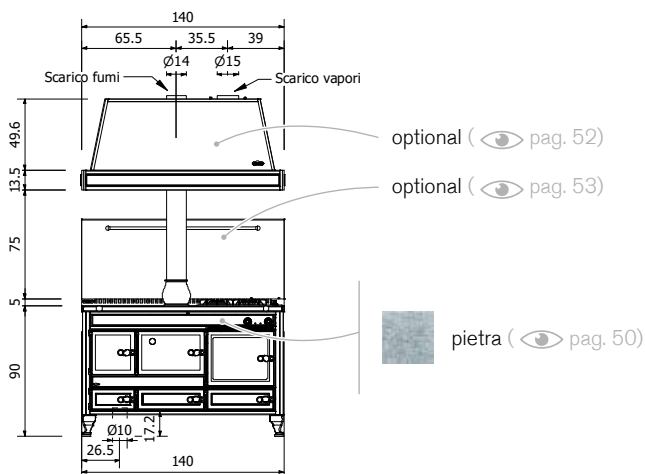







Cucina combinata che integra una cucina a legna, un forno elettrico multifunzione e un piano cottura a gas o induzione in un unico monoblocco. I profili e le finiture in rame e il rivestimento in pietra serpentino bocciardata con decoro realizzato a mano rendono questo modello ideale per ambienti di montagna o di campagna. Disponibile anche nella versione termo.





Combined cooker including a wood-burning cooker, a multifunction electric oven and a gas or induction hob in a single monobloc. Its copper profiles and finishes as well as its bush-hammered serpentine stone cladding with hand-made decoration make this model ideal for mountain or countryside environments. Also available in the thermo-version.

Cuisinière combinée intégrant une cuisinière à bois, un four électrique multifonction et une plaque de cuisson à gaz ou à induction dans un seul monobloc. Les profilés et les finitions en cuivre ainsi que le revêtement en pierre serpentine bouchardée avec décoration faite à la main rendent ce modèle idéal pour les environnements de montagne ou de campagne. Également disponible en version thermo.



		
 kW	9,3	13,3
 kW	-	8,2
 kW	-	5,1
 m³	200÷320	280÷450
 %	82,7	85

		
 kg	358	341
 cm	Ø 14	Ø 14
 cm	25 → 51	19 → 52
 cm	26 → 44	26 → 44
 Pa	11	12

		
 A+	A+	A+
DM 186	★★★★	★★★
 kg/h	2,5	3,6
 cm	50	50

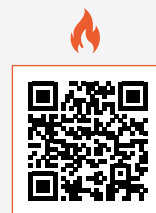

MR360

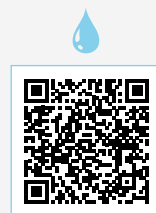

TMR360

# HARMONY 150 LGE



Cucina combinata formata dall'accostamento della cucina a legna da 90 cm e della cucina di cottura da 60 cm. Robustezza ed estetica sono i suoi punti di forza. La piastra di cottura è in acciaio di grosso spessore, garanzia di qualità e durata. Il rivestimento è realizzato in lamiera smaltata in diversi colori. Disponibile anche nella versione termo.

Combined cooker resulting from the combination of the 90 cm wood-burning cooker and the 60 cm cooking range. Robustness and aesthetics are its strong points. The cooking hob is made of thick steel, a guarantee of quality and durability. The cladding is made of enamelled sheet metal in different colours. Also available in the thermo-version.

Cuisinière combinée résultant de la fusion d'une cuisinière à bois de 90 cm et d'une cuisinière de 60 cm. Elle allie robustesse et esthétique. La plaque de cuisson, en acier épais, est un gage de qualité et de durabilité. Le revêtement est en tôle émaillée, disponible en différentes couleurs. Également disponible en version thermo.

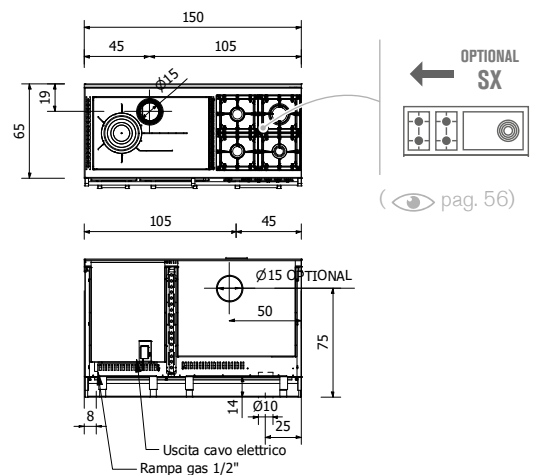
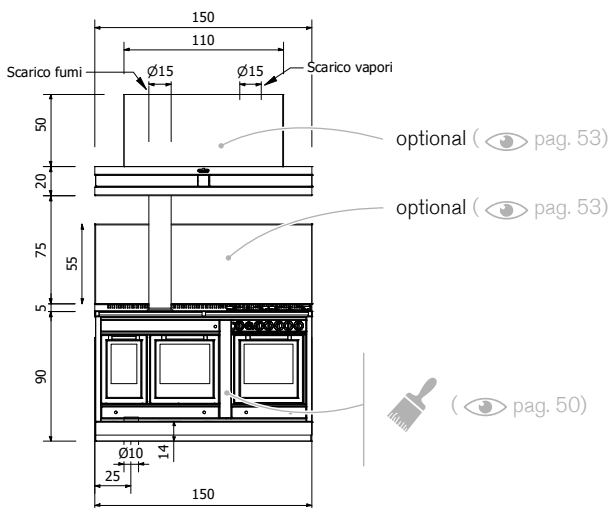

kW	9,3	13,3
kW	-	8,2
kW	-	5,1
m³	200÷320	280÷450
%	82,7	85

kg	350	383
cm	Ø 15	Ø 15
cm	25 25 51 51	19 19 52 52
cm	31 31 45 45	31 31 45 45
Pa	11	12

A+	A+	A+
DM 186	★★★★	★★★
kg/h	2,5	3,6
cm	50	50

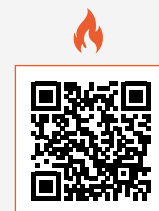

CH150



TCH150



# HARMONY 165 LGE









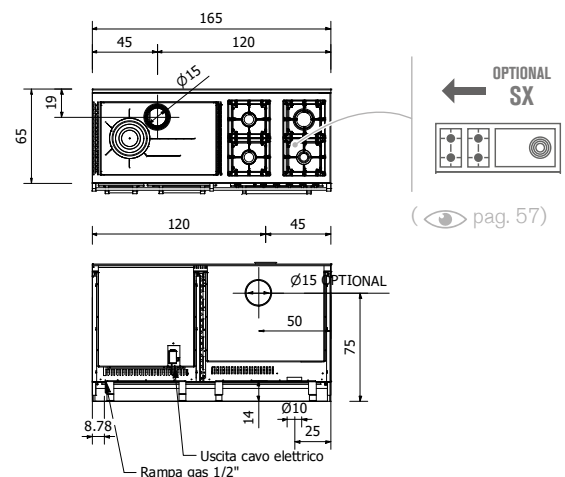
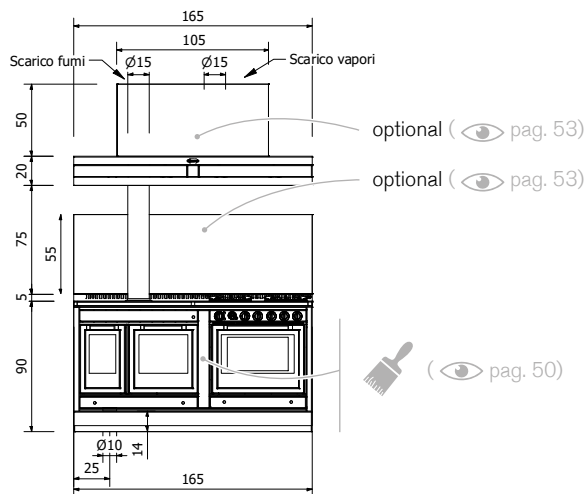







Combinazione tra la cucina a legna da 90 cm e la cucina di cottura da 75 cm. Pratica e funzionale, si integra facilmente in diversi stili e arredi. Grazie alla possibilità di personalizzazione, questa cucina è in grado di soddisfare le esigenze di ogni cliente. Disponibile anche nella versione termo.







Combination of the 90 cm wood-burning cooker and the 75 cm cooking range. Practical and functional, it easily integrates into different styles and furnishings. Thanks to the possibility of customization, this kitchen will satisfy the needs of every customer. Also available in the thermo-version.

Combinaison d'une cuisinière à bois de 90 cm et d'une cuisinière de 75 cm. Pratique et fonctionnelle, elle s'intègre facilement dans différents styles et ameublements. Grâce à la possibilité de personnalisation, cette cuisinière répond aux besoins de chaque client. Également disponible en version thermo.



		
 kW	9,3	13,3
 kW	-	8,2
 kW	-	5,1
 m³	200÷320	280÷450
 %	82,7	85

		
 kg	373	405
 cm	Ø 15	Ø 15
 cm	25 → 51	25 → 52
 cm	31 → 45	31 → 45
 Pa	11	12

		
 A+	A+	A+
 DM 186	★★★★	★★★
 kg/h	2,5	3,6
 cm	50	50

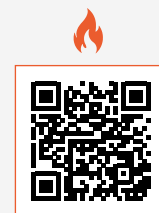

CH165

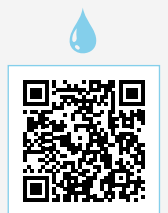

TCH165

# HARMONY 180 LGE









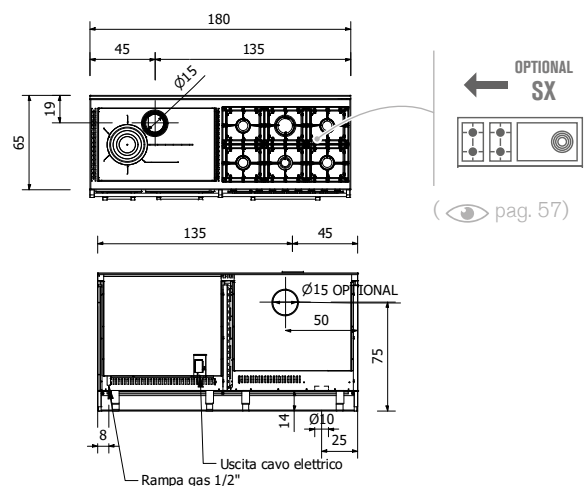
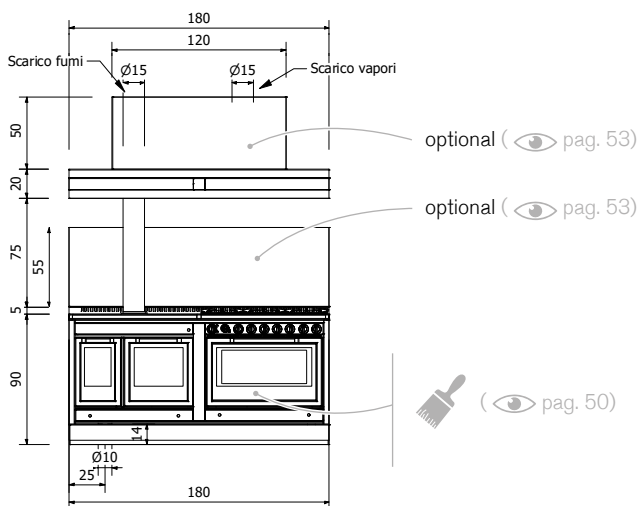







Cucina combinata formata dall'accostamento della cucina a legna e della cucina di cottura entrambe di 90 cm. Progettata e costruita per integrarsi armoniosamente in tutte le ambientazioni, rende unico lo spazio dedicato alla cucina. È possibile scegliere fra diverse soluzioni per il piano cottura, per le finiture delle parti metalliche e per i colori del rivestimento. Disponibile anche nella versione termo.

Combined cooker formed by the blend of the wood-burning cooker and the cooking range, both 90 cm. Designed and built to harmoniously integrate into all settings, it makes the kitchen unique. It is possible to choose among different solutions as to hob, finishes of the metal parts, as well as for the cladding colours. Also available in the thermo-version.

Cuisinière combinée résultant de l'association d'une cuisinière à bois et d'une cuisinière, toutes deux de 90 cm. Conçue et construite pour s'intégrer harmonieusement dans tous les environnements, elle apportera une touche unique à votre espace cuisine. Il est possible de choisir parmi différentes solutions pour la plaque de cuisson, pour les finitions des parties métalliques et pour les couleurs du revêtement. Également disponible en version thermo.



		
 kW	9,3	13,3
 kg	400	430
 cm	Ø 15	Ø 15
 cm	25 / 51	25 / 52
 cm	31 / 45	31 / 45
 Pa	11	12

		
 A+	A+	A+
 DM 186	★★★★	★★★
 kg/h	2,5	3,6
 cm	50	50

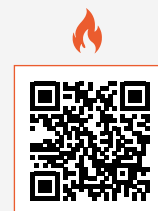

CH180

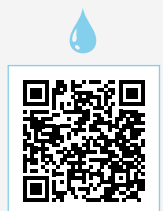

TCH180





# CUCINE DI COTTURA



# COOKING APPLIANCES CUISINIÈRES



# ANTICO CASALE 60 GE



Cucina di cottura di piccole dimensioni ma con alte prestazioni. È dotata di forno multifunzione e di un top cottura a scelta fra diverse soluzioni, gas o induzione. Disponibile in molte varianti estetiche.

Small, yet high-performance cooker. It is equipped with a multifunction oven and a cooking hob with a wide range of different solutions, gas or induction. Available in many aesthetic variations.

Petite, mais performante, cette cuisinière est équipée d'un four multifonction et d'une plaque de cuisson offrant plusieurs options, à gaz ou à induction. Disponible dans de nombreuses versions esthétiques.

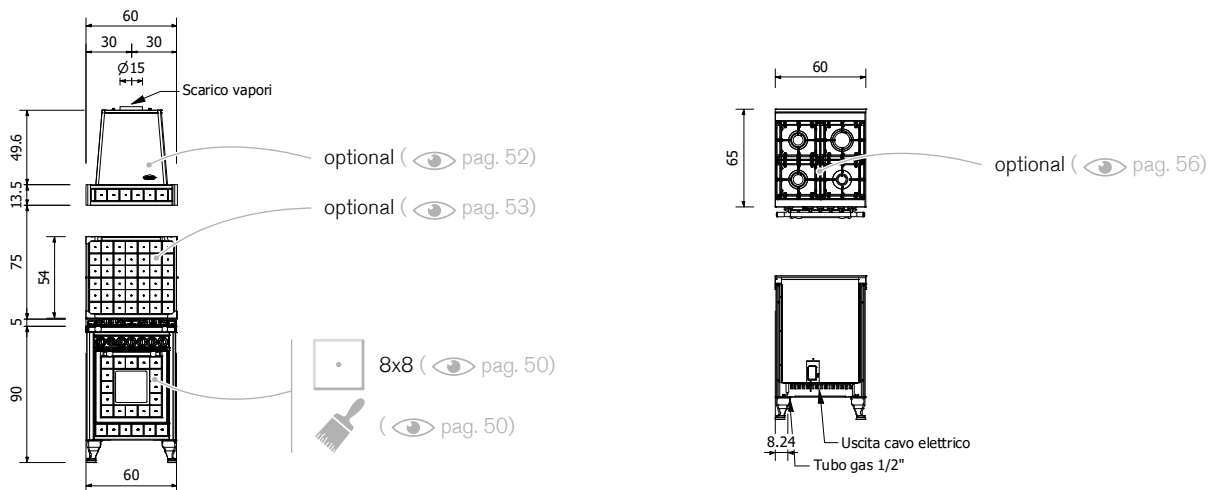

	kW	<b>2,7</b>
	kg	<b>120</b>
	cm	42 32,5 45
	lt	<b>61,5</b>



AC60GE

# ANTICO CASALE 75 GE



Cucina di cottura di medie dimensioni ma con ottime prestazioni, grazie all'ampio forno multifunzione e al top cottura a gas, induzione o misto. Le molteplici possibilità di finitura e rivestimento la rendono adatta a qualsiasi ambiente.

Medium-sized cooking range, yet with excellent performance thanks to its large multifunction oven and the gas, induction or mixed cooking hob. The multiple finishing and cladding options make it suitable for any environment.

Cuisinière de taille moyenne, mais offrant d'excellentes performances grâce à son grand four multifonction et à sa plaque de cuisson à gaz, à induction ou mixte. Les multiples possibilités de finition et de revêtement la rendent adaptée à tout environnement.

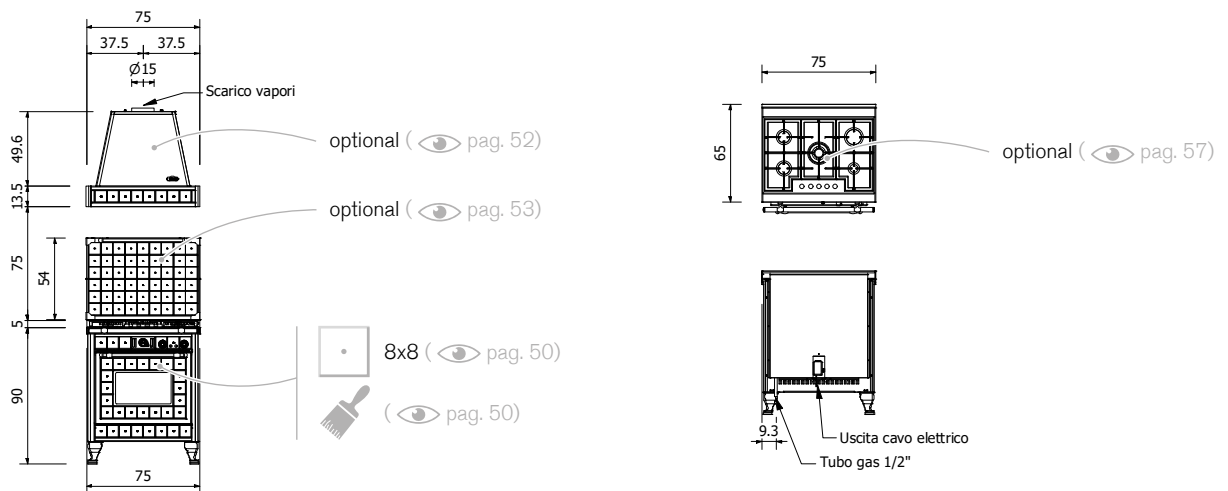

	kW	<b>2,7</b>
	kg	<b>142</b>
	cm	<b>52</b> <sup>32,5</sup> <sup>45</sup>
	lt	<b>76</b>



AC75GE

# ANTICO CASALE 90 GE



Cucina di cottura professionale dotata di un grande forno multifunzione e di soluzioni diverse per il top cottura. Le molteplici finiture e i diversi rivestimenti permettono di personalizzare la cucina secondo la propria fantasia e il proprio ambiente.

Professional cooker equipped with a large multifunction oven and different solutions for the cooking hob. The multiple finishes and different claddings allow you to customize the cooker according to your imagination and environment.

Cuisinière professionnelle équipée d'un grand four multifonction et de plusieurs options pour la plaque de cuisson. Les multiples finitions et différents revêtements vous permettront de personnaliser votre cuisinière selon votre imagination et votre environnement.

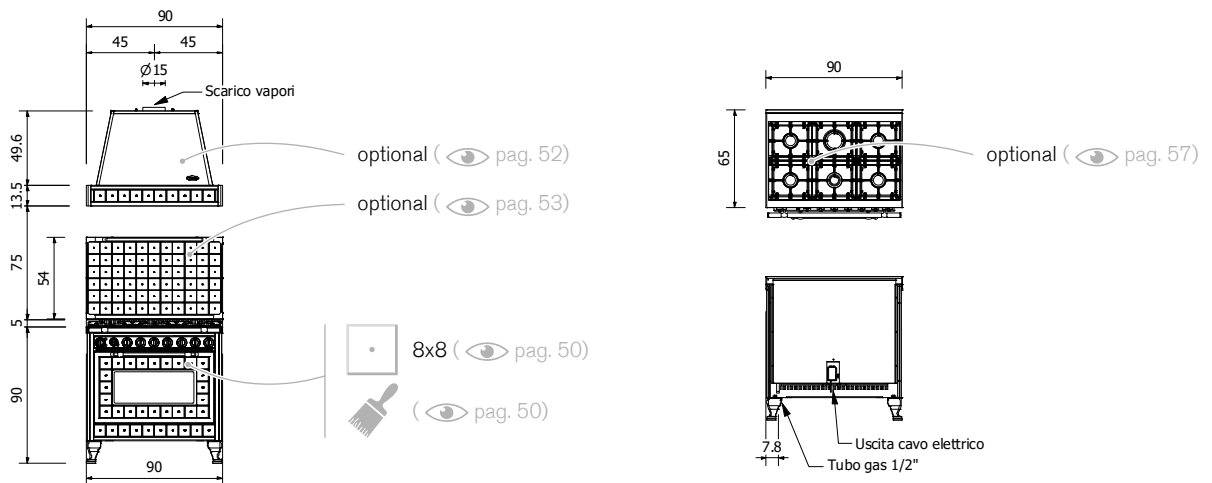

	kW	<b>2,7</b>
	kg	<b>170</b>
	cm	64 32,5 45
	lt	<b>94</b>



AC90GE



# HARMONY 60 GE



Cucina di cottura lineare ma robusta di dimensioni contenute e di alte prestazioni. Sono disponibili diverse soluzioni per il top cottura. Il forno è elettrico multifunzione. Sotto al forno è presente un cassetto porta utensili.

Linear yet robust cooking range of small size and high performance. Different solutions are available for the cooking hob. The oven is an electric multifunction model. Under the oven there is a drawer for utensils.

Cuisinière linéaire, robuste, de petites dimensions et offrant de hautes performances. Plusieurs options sont disponibles pour la plaque de cuisson. Le four est électrique et multifonctionnel, et un tiroir à ustensiles se trouve sous le four.

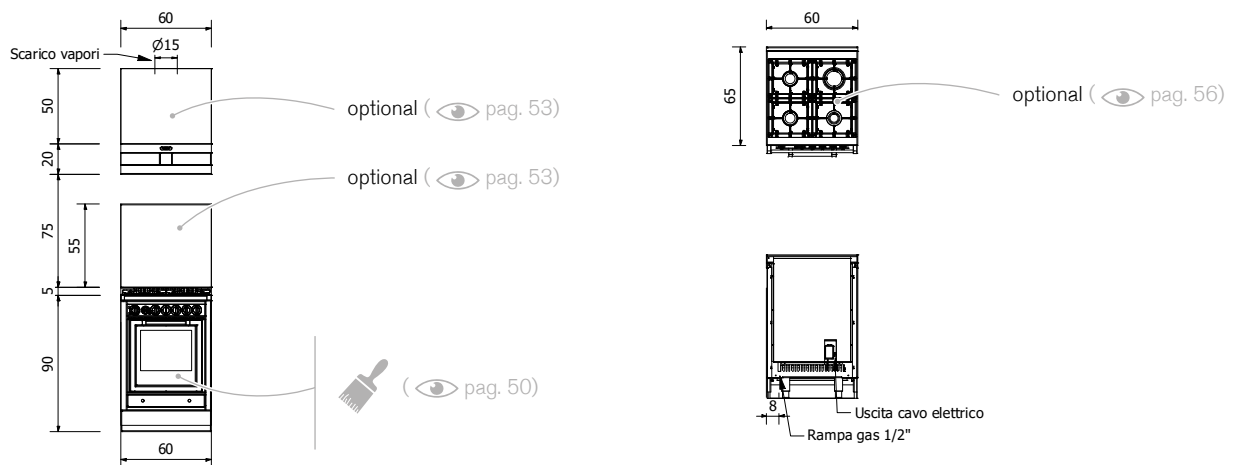

	kW	<b>2,7</b>
	kg	<b>120</b>
	cm	42 32,5 45
	lt	<b>61,5</b>



CH60GE

# HARMONY 75 GE





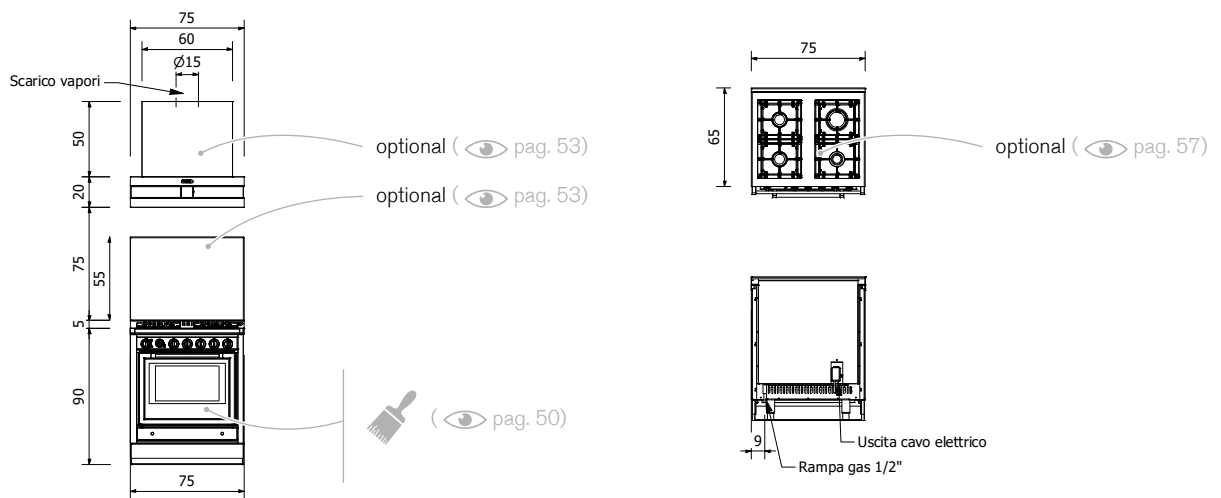

Cucina di cottura robusta di medie dimensioni adatta a qualsiasi ambiente e arredamento. La cucina è dotata di un ampio forno multifunzione e di un cassetto inferiore porta utensili. È possibile scegliere il top cottura tra diverse soluzioni: gas, induzione o misto.

Robust medium-sized cooking range suitable for any environment and decor. The cooking range is equipped with a large multifunction oven and a lower drawer for utensils. You can choose the cooking hob from different solutions: gas, induction or mixed.

Cuisinière robuste de taille moyenne adaptée à tout environnement et décor. La cuisinière est équipée d'un grand four multifonction et d'un tiroir inférieur pour les ustensiles. Vous pourrez choisir la plaque de cuisson parmi différentes options : gaz, induction ou mixte.



 kW	<b>2,7</b>
 kg	<b>142</b>
 cm	<b>52</b> <span style="margin-left: 20px;"><b>32,5</b></span> <span style="margin-left: 20px;"><b>45</b></span>
 lt	<b>76</b>



CH75GE

# HARMONY 90 GE



Cucina di cottura professionale dotata di un grande forno multifunzione, di un ampio cassetto inferiore porta utensili e di diverse soluzioni per il top cottura. È possibile personalizzare il prodotto scegliendo le finiture e il colore del rivestimento che più si adattano al proprio ambiente.

Professional cooking range equipped with a large multifunction oven, a large lower drawer for utensils and various solutions for the cooking hob. The product can be customized by selecting the cladding finishes and colours that best suit your environment.

Cuisinière professionnelle équipée d'un grand four multifonction, d'un grand tiroir inférieur pour les ustensiles et de diverses solutions pour la plaque de cuisson. Il est possible de personnaliser le produit en choisissant les finitions et la couleur du revêtement qui s'intègrent le mieux à votre environnement.

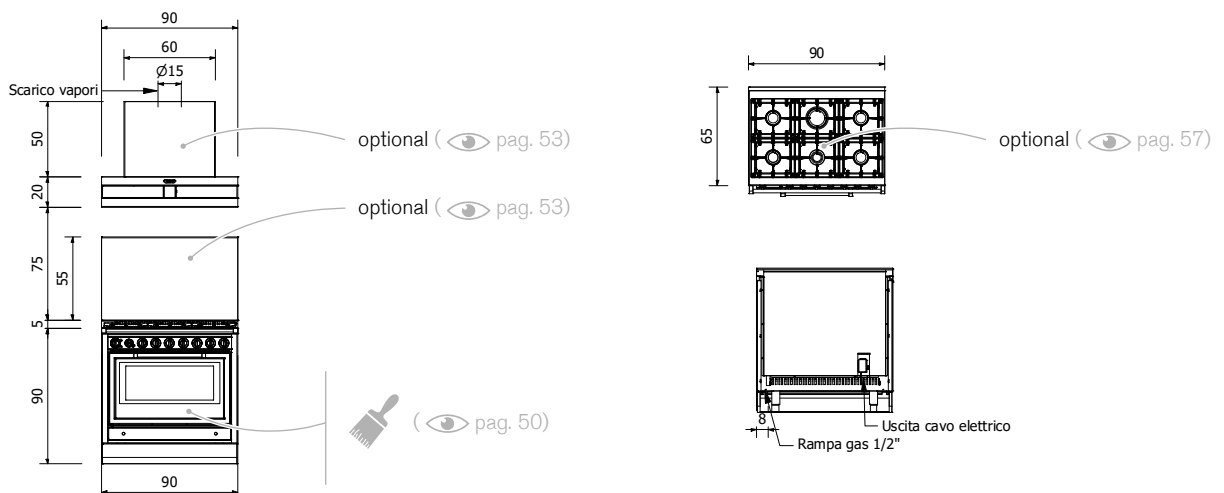

	kW	<b>2,7</b>
	kg	<b>170</b>
	cm	64 32,5 45
	lt	<b>94</b>



CH90GE



# RIVESTIMENTI E ACCESSORI

CLADDINGS  
AND ACCESSORIES

REVÊTEMENTS  
ET ACCESSOIRES



# □ Piastrelle per cucine 8x8

Tiles for cookers 8x8 | Carreaux pour cuisinières 8x8



UVD 08 UGD 08



08 UB 08



08 OVD 08



08 OLD 08



08 OB 08



B2 OLD B2



B2 OVD B2



U4 04 O4  
OLIVO  
ROSSO

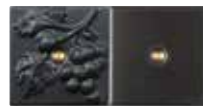

U5 05



U6 06 O6  
OLIVO  
VERDE



M 7  
FLOR



M 7  
FOLHAS



M 3  
TORTORA



M 7  
BIANCO



M 9  
GRIGIO  
FUMO

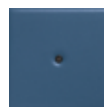

M 10  
AZZURRO



M 12  
CARTA DA  
ZUCCHERO



M 13  
VERDE  
CHIARO



PIETRA SERPENTINO BOCCIARDATA  
MONTE ROSA 90 - 360  
SU RICHIESTA PER GLI ALTRI MODELLI

SERPENTINO STONE BUSH-HAMMERED  
MONTE ROSA 90 - 360  
ON REQUEST FOR OTHER MODELS

PIERRE SERPENTINE BOUCHARDÉE  
MONTE ROSA 90 - 360  
SUR DEMANDE POUR LES AUTRES MODÈLES

## Smalti per cucine

Enamelles for cookers | Emaux pour cuisinières



AVORIO  
IVORY  
IVOIRE



ROSSO SCURO  
DARK RED  
ROUGE FONCÉ



NERO MATT  
MATT BLACK  
NOIR MATT



RAL

COLORE RAL A RICHIESTA  
RAL COLOR ON DEMAND  
COULEUR RAL SUR DEMANDE

# Finiture

## Finishes | Finitions



RUSTICA  
RUSTIC  
RUSTIQUE



INOX SATINATO  
SATIN STAINLESS STEEL  
CHROME SATINÉ



INOX LUCIDO  
POLISHED STAINLESS STEEL  
CHROME BRILLANT



RAME  
COPPER  
CUIVRE



OTTONE LUCIDO  
POLISHED BRASS  
LAITON BRILLANT



OTTONE SATINATO  
SATIN BRASS  
LAITON SATINÉ



OTTONE ANTICO  
ANTIQUE BRASS  
LAITON ANTIQUE

# Cappe Aspiranti Antico Casale

## Antico Casale Extractor Hoods | Hotte Aspirantes Antico Casale



CORPO CAPPÀ COLORE BIANCO  
WHITE HOOD COLOUR  
CORPS HOTTE BLANC



CORPO CAPPÀ COLORE NERO  
BLACK HOOD COLOUR  
CORPS HOTTE NOIR



CORPO CAPPÀ COLORE AVORIO  
IVORY HOOD COLOUR  
CORPS HOTTEIVOIRE



CORPO CAPPÀ COLORE ROSSO SCURO  
DARK RED HOOD COLOUR  
CORPS HOTTE ROUGE FONCÉ

### OPTIONAL

FILTRI A CARBONI ATTIVI  
ACTIVE CARBON FILTERS  
FILTRÉS À CHARBON ACTIF

CORPO CAPPÀ COLORE RAL A SCELTA  
HOOD BODY RAL COLOUR OF YOUR CHOICE  
CORPS DE LA HOTTE EN COULEUR RAL AU CHOIX

ESTENSIONE CAPPÀ  
HOOD EXTENSION  
REHAUSSE DE HOTTE

Le cappe aspiranti sono realizzate in metallo verniciato a fuoco con struttura interna in acciaio inox. Sono complete di luce, filtri inox lavabili e aspiratore potente e silenzioso a tre velocità.

Il rivestimento della fascia centrale può essere in pannelli verniciati o piastrelle 8x8 in abbinamento al rivestimento della cucina.

The extractor hoods are made of baked enamel finished metal with an internal structure in stainless steel. They are complete with light, washable stainless steel filters as well as a powerful and silent three-speed extractor.

The covering of the central band can be in painted panels or 8x8 tiles matching with the cooker's cladding.

Les hottes aspirantes sont en métal émaillé au four avec une structure interne en acier inoxydable. Elles sont équipées de filtres en acier inoxydable légers et lavables et d'un extracteur puissant et silencieux à trois vitesses.

Le revêtement de la bande centrale peut être en panneaux peints ou en carreaux 8x8 combinés au revêtement de la cuisine.

INTERNO CAPPÀ  
HOOD INTERIOR  
INTÉRIEUR HOTTE



### OPTIONAL

CORPO CAPPÀ IN ACCIAIO INOX  
STEINLESS STEEL HOOD BODY  
CORPS DE LA HOTTE EN ACIER INOXYDABLE

# Cappe Aspiranti Harmony

## Harmony Extractor Hoods | Hotte Aspirantes Harmony



Le cappe aspiranti sono realizzate interamente in acciaio inox, complete di luce, filtri inox lavabili e aspiratore potente e silenzioso a tre velocità.

A richiesta, disponibili in soluzioni estetiche differenti (optional).

The Harmony extractor hoods are entirely made of stainless steel, complete with light, washable stainless steel filters and a powerful and silent three-speed extractor.

On request, they are available in different aesthetic solutions (optional).

Les hottes aspirantes sont fabriquées entièrement en acier inoxydable, avec lampe, filtres en acier inoxydable lavables et un extracteur puissant et silencieux à trois vitesses.

Sur demande, disponible dans plusieurs solutions esthétiques (à option).

# Pannelli a Muro

## Wall Panels | Panneaux Mureaux



PANNELLO ACCIAIO INOX  
STAINLESS STEEL PANEL  
PANNEAU ACIER INOX



PANNELLO PIASTRELLATO 8X8  
TILED PANEL 8X8  
PANNEAU CARRELÉ 8X8

Sono realizzati in acciaio inox satinato o in metallo rivestiti di piastrelle 8x8 e cornice perimetrale coordinata alle finiture della cucina.

They are made of satin stainless steel or metal, clad with 8x8 tiles and a perimeter frame matching the cooker's finishes.

Ils sont fabriqués en acier inoxydable satiné ou en métal recouvert de carreaux de 8x8 et d'un cadre périmétrique coordonné à la finition de la cuisinière.

# Optional

Optional | Optional

## Piedi | Feet | Pieds



LISCIO  
SMOOTH FOOT  
PIED LISSES



INOX  
CHROME  
CHROME



NERO  
BLACK  
NOIR



OTTONE  
BRASS  
LAITON



OTTONE ANTICO  
ANTIQUE BRASS  
LAITON VIEILLI



RAME  
COPPER  
CUIVRE

## Maniglia rustica | Rustic handle | Poignée rustique



INOX  
CHROME  
CHROME



OTTONE  
BRASS  
LAITON



OTTONE ANTICO  
ANTIQUE BRASS  
LAITON VIEILLI



RAME  
COPPER  
CUIVRE

## Maniglia in porcellana | Porcelain handle | Poignée en porcelaine



INOX  
E PORCELLANA BIANCA  
STAINLESS STEEL  
AND WHITE PORCELAIN  
INOX  
ET PORCELLANE  
BLANCHE



OTTONE  
E PORCELLANA  
AVORIO  
BRASS AND IVORY  
PORCELAIN HANDLE  
LAITON ET  
PORCELAINE IVOIRE

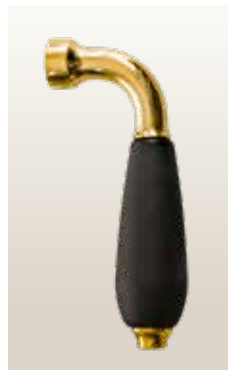

OTTONE  
E PORCELLANA NERA  
BRASS AND  
BLACK PORCELAIN  
LAITON  
ET PORCELAINE  
NOIRE



OTTONE ANTICO  
E PORCELLANA NERA  
ANTIQUE BRASS AND  
BLACK PORCELAIN  
HANDLE  
LAITON VIEILLI ET  
PORCELAINE NOIR

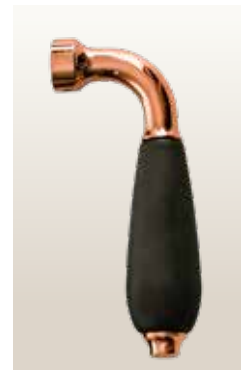

RAME  
E PORCELLANA NERA  
COPPER  
AND BLACK  
PORCELAIN HANDLE  
CUIVRE  
ET PORCELAINE NOIR

# Optional

Optional | Optional

## Vaschette | Reservoir | Cuves



VASCETTA PER ACQUA IN OTTONE CROMATO  
CHROMIUM-PLATED WATER RESERVOIR  
CUVE POUR EAU LAITON CHROMÉ



VASCETTA PER ACQUA IN OTTONE  
BRASS WATER RESERVOIR  
CUVE POUR EAU LAITON

## Portalegna | Log stackers | Porte-bûches



PL 3-P8  
NERO  
BLACK  
NOIR

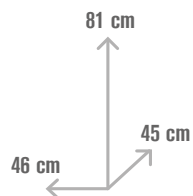

PL 2-P8  
NERO  
BLACK  
NOIR

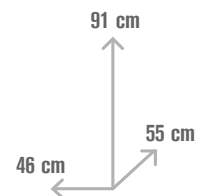

## Corrimano laterale | Side handrail | Main courante sur les côtés



CORRIMANO CON CURVA  
BENT HANDRAIL  
MAIN COURANTE COURBÉE



CORRIMANO STACCATO  
SIDE HANDRAIL  
WITHOUT CURVE  
MAIN COURANTE SANS  
COURBE

# Piani cottura

## Cooktops | Plaques de Cuisson

MODELLO CUCINA  
COOKER MODEL  
MÔDELE DE CUISINIÈRE

PIANO COTTURA DISPONIBILE  
AVAILABLE COOKTOP  
PLAQUE DE CUISSON DISPONIBILE

120 LGE  
120 LGE/F LOBELIA  
ANTICO CASALE 360 LGE  
MONTE ROSA 360

TOP 60 00A

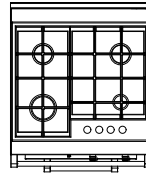

TOP 60 06

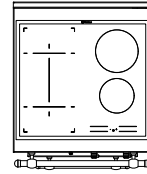

TOP 60 00F

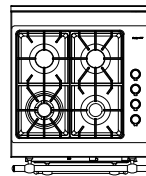

ANTICO CASALE 150 LGE  
ANTICO CASALE 160 LGE  
HARMONY 150 LGE

TOP 60 00A

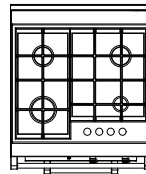

TOP 60 02

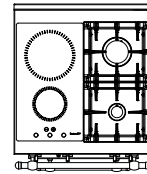

TOP 60 00F

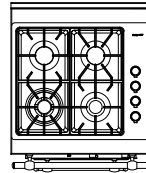

TOP 60 04

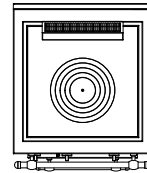

ANTICO CASALE 60 GE  
HARMONY 60 GE

TOP 60 01

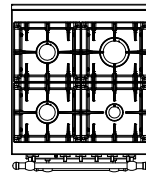

TOP 60 06

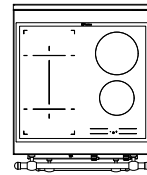



# Piani cottura

## Cooktops | Plaques de Cuisson

MODELLO CUCINA  
COOKER MODEL  
MÔDELE DE CUISINIÈRE

PIANO COTTURA DISPONIBILE  
AVAILABLE COOKTOP  
PLAQUE DE CUISSON DISPONIBILE

135 LGE VIOLETTA  
135 LGE/F ARNICA  
ANTICO CASALE 165 LGE  
ANTICO CASALE 175 LGE  
HARMONY 165 LGE

ANTICO CASALE 75 GE  
HARMONY 75 GE

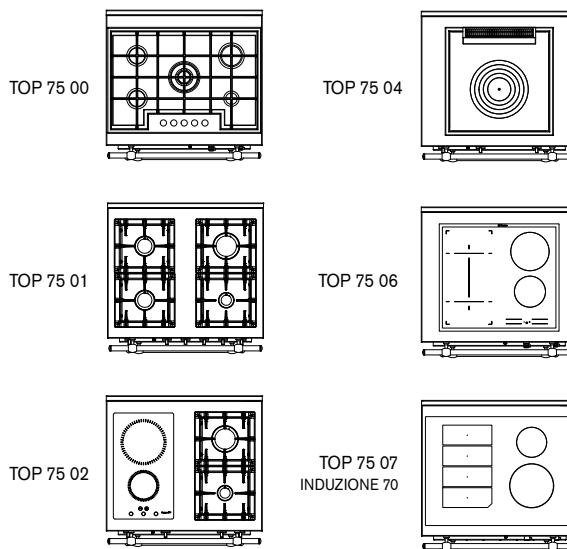

ANTICO CASALE 180 LGE  
ANTICO CASALE 190 LGE  
HARMONY 180 LGE

ANTICO CASALE 90 GE  
HARMONY 90 GE

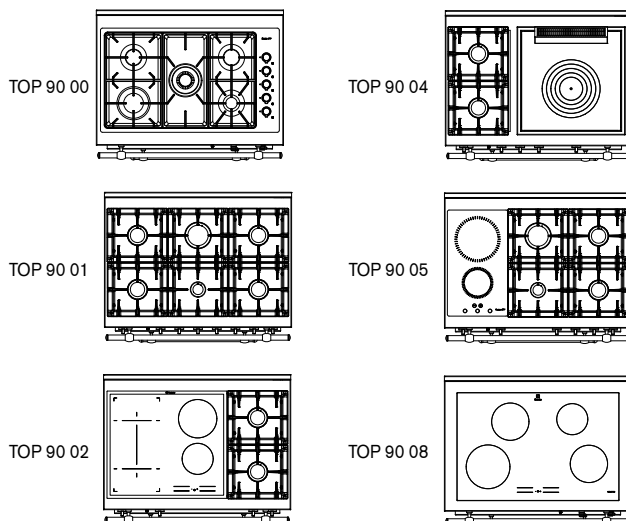

**Special thanks to**

B&B Campo Base - Carone (BG) - [www.bbcampobase.it](http://www.bbcampobase.it)  
Quinta da Mata de Baixo, Dornes - Portogallo - [www.qmb.pt](http://www.qmb.pt)



WEKOS

**WEKOS srl.**

Via dell'Industria, 18  
37066 Sommacampagna (VR), Italy  
Tel. +39 045 8960108  
Fax +39 045 8960725  
wekos@wekos.it  
www.wekos.it

